

Smart 60cm Svart glas | 110.0377.736

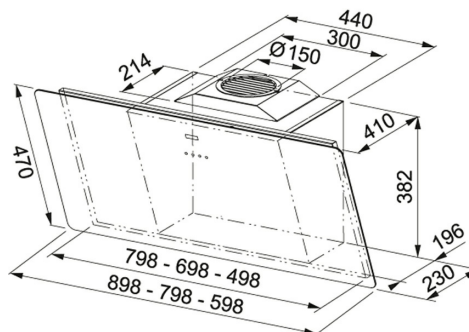







FAMILJ: Fläktar | FÄRG/MATERIAL: Svart glas | INSTALLATIONSTYP: Väggmonterad | PRODUKTGRUPP: Spisfläkt |
PRODUKTLINJE: Smart | SERIE: Design | MODELL: Smart 60cm | PRODUKTGRUPP: Kolfilterfläkt | VENTILATIONSTEKNIK:
Standard



TEKNISKA DATA

Type	DECORATIVE
Installationstyp	Väggmonterad
Bredd	60,00 cm
Luftmängd DIN IEC 61591 Int.	700 m3/h
Luftmängd DIN IEC 61591 max.	580 m3/h
Luftmängd DIN IEC 61591 min.	302 m3/h
Ljudeffektsnivå DIN EN 60704-3 Int.	69 dB(A)
Ljudeffektsnivå DIN EN 60704-3 max.	64 dB(A)
Ljudeffektsnivå DIN EN 60704-3 min.	49 dB(A)
Effekt	270 W
Belysning	LED 2 x 1W
Voltage	220-240V
Typ av brytare	Elektronisk Touch
Montagehöjd min.	450 mm
Medföljande tillbehör	112.0016.755
Kanalanslutning	Ø 150
Produktgrupp	Spisfläkt
Produktgrupp	Kolfilterfläkt
Energieffektivitetsklass	A
Djup (mm)	410,00 mm
Höjd (mm)	1 382,00 mm
Bredd (mm)	598,00 mm

ÖVRIGT

	Timerfunktion		Ventilationslä
	Kantutsug		3
			hastigheter
			+ Intensiv
	Bredd 60		Easy Fit
	cm		System
	Energy		Digital
	Motor		display

Smart 60cm Svart glas | 110.0377.736

FAMILJ : **Fläktar** | FÄRG/MATERIAL : **Svart glas** | INSTALLATIONSTYP : **Väggmonterad** | PRODUKTGRUPP : **Spisfläkt** |
PRODUKTLINJE : **Smart** | SERIE : **Design** | MODELL : **Smart 60cm** | PRODUKTGRUPP : **Kolfilterfläkt** | VENTILATIONSTEKNIK :
Standard

FÖRESLAGNA PRODUKTER



110.0377.734

110.0377.735

110.0310.492

110.0310.494



330.0489.611

330.0489.613
