

## Inspection Certificate

Kontrollschein • Bulletin de contrôle • Certificado de control • Certificato di controllo • Kontrollskjema • Besiktningsprotokoll • Tarkastustodistus • Kontrol Certifikat • Control Certificaat • Certificado de Inspeção • Kontrolní certifikát • Certyfikat kontrolny • Apžiūros pažyma • Pārbaudes akts • Акт осмотра • Kontrollakt

Art. Nr. PA28-2929-2

### Please keep safely!

Bitte gut aufbewahren! • A bien conserver, s.v.p.! • ¡A conservar! • Da conservare! • Ta vare på denne! • Vänligen förvara säkert! • Ole hyvä ja säilytä huolella! • Opbevares sikkert! • Zorgvuldig te bewaren! • Por favor, guarde em segurança! • Prosím, pečlivě uschovejte! • Przechowywać w bezpiecznym miejscu! • Laikykite saugiai! • Lūdzu, glabājiet drošā vietā! • Хранить в надежном месте! • Palun säilitada hoolsalt!

**English:** The product you have purchased was manufactured in accordance with the high quality norms. The product unit has been carefully inspected and packed. In order to avoid possible problems during the assembly carried out by yourself or the building company of your choice, we recommend that you inspect the delivery for its completeness in accordance with the list of pieces before assembly. This inspection must be carried out within 14 days after delivery to your place. Warranty claims are limited to the exchange of defective materials. Defective product parts, which have already been used or painted, are excluded from being replaced. All further claims are excluded! In cases of complaints, please pay attention to the following procedures: Please present this inspection certificate along with the sales receipt to your place of purchase. Only in cases where these documents are presented will the complaint be dealt with quickly and without complications.

**Deutsch:** Der von Ihnen gekaufte Artikel wurde nach der hohen Qualitätsnorm gefertigt. Der Bausatz wurde sorgfältig geprüft und verpackt. Um etwaige auftretende Probleme während des Aufbaus durch Sie oder Ihre Aufbaufirma zu vermeiden, kontrollieren Sie bitte die Lieferung auf Vollständigkeit laut Stückliste vor dem Aufbau. Diese Kontrolle muss innerhalb 14 Tagen nach Anlieferung bei Ihnen erfolgen. Ansprüche auf Gewährleistung beschränken sich auf den Austausch von fehlerhaftem Material. Fehlerhafte Bauteile, die bereits verbaut oder gestrichen wurden, sind vom Umtausch ausgeschlossen. Alle weiteren Ansprüche sind ausgeschlossen! Sollte es zu einer Beanstandung kommen, beachten Sie folgende Vorgehensweise: Legen Sie Ihrem Fachhändler diesen Kontrollschein zusammen mit dem Einkaufsbeleg vor. Nur bei Vorlage dieser Unterlagen ist eine schnelle und problemlose Bearbeitung Ihrer Beanstandung möglich.

**Français:** Le produit que vous venez d'acheter a été fabriqué en respectant de hautes normes de qualité. Ce produit a été testé et emballé avec soin. Afin d'éviter des problèmes éventuels pendant la construction par vous-même ou par la société de construction mandatée, nous vous prions de bien vouloir vérifier que toutes les pièces ont été fournies selon la liste des pièces avant que vous ne commenciez la construction. Il vous incombe de faire ce contrôle dans les 14 jours après la fourniture. Les revendications en dédommagement se limitent à l'échange de matériel défectueux. Les pièces défectueuses, déjà construites ou peintes, ne font pas l'objet de l'échange. Toutes les revendications ultérieures ne sont pas prises en compte ! En cas d'une réclamation, veuillez respecter le déroulement suivant : il vous faudra présenter à votre commerçant agréé ce bulletin de contrôle avec le récépissé de l'achat. Ce ne sera que moyennant présentation de ces documents qu'un traitement rapide et sans problème de votre réclamation sera possible!

**Español:** El producto que ha adquirido ha sido fabricada de acuerdo con normas de alta calidad. Las piezas del producto han sido cuidadosamente inspeccionadas y embaladas. Con el fin de evitar posibles problemas durante el montaje, hecho por usted o por la empresa de construcción de su elección, le recomendamos revisar el paquete entregado, con la lista de piezas, antes de armar el producto. Haga la revisión dentro de 14 días después de recibir el paquete. La garantía se limita a reemplazar las piezas defectuosas. No se reemplazarán las partes defectuosas que ya hayan sido utilizadas o pintadas. ¡No se aceptan otras reclamaciones! En casos de queja, por favor, presente este certificado junto con la factura en el lugar donde hizo la compra. Sólo presentando estos documentos podremos resolver su problema rápidamente y sin complicaciones.

**Italiano:** Il prodotto che avete acquistato è stata prodotta secondo la norma di alta qualità. Il kit è stato controllato ed imballato con cura. Per evitare eventuali inconvenienti durante il montaggio, si prega di verificare, prima del montaggio, la completezza della fornitura in base alla distinta dei pezzi. Tale verifica deve essere effettuata entro 14 giorni dalla consegna. Eventuali diritti di garanzia si limitano alla sostituzione di materiale difettoso. Gli elementi difettosi già montati o verniciati sono esclusi dal diritto alla sostituzione. Ogni altro diritto resta escluso! In caso di reclamazione, procedere nel modo seguente: presentare questo certificato di controllo unitamente alla prova d'acquisto al rivenditore. Solo in questo modo la Sua reclamazione potrà essere evasa rapidamente e senza problemi.

**Norsk:** Produktet du har kjøpt, ble produsert i henhold til høye kvalitetskrav. Produktet har blitt kontrollert nøye og deretter omhyggelig pakket. For å unngå mulige problemer under monteringen, uansett om du gjør det selv eller får en godkjent håndverker til å gjøre det, anbefaler vi at du kontrollerer leveransen mot delelisten for å se om alle delene er inkludert. Denne kontrollen må gjøres innen 14 dager etter at delene ble levert til din adresse. Garantikrav begrenser seg til bytte av defekte deler. Defekte elementer som allerede har blitt brukt eller malt/beiset/limt, vil ikke bli erstattet. Alle andre krav er utelukket! Dersom du har en reklamasjon, vennligst gjør som følger: Lever dette kontrollskjema med kvitteringen til salgsstedet. Bare når du har med disse dokumentene kan klagen behandles raskt og uten komplikasjoner.

**Svenska:** Produkten du köpt har tillverkats i enlighet med de högsta kvalitetsstandarderna. Produktens delar har noggrant besiktigats och förpackats. För att undvika eventuella problem under monteringen som du utför själv eller låter en hantverkare att utföra, rekommenderar vi att du, innan monteringen påbörjas, besiktigar leveransen för att säkerställa att den är komplett enligt förteckningen över ingående delar. Denna besiktning måste utföras inom 14 dagar efter att du tagit emot leveransen. Garantianspråk är begränsade till ersättning av defekt material. Defekta produkt delar, vilka redan har använts eller målats, ersätts inte. Alla vidare anspråk avvisas! I händelse av reklamationer, vänligen uppmärksamma följande: uppvisa detta besiktningsprotokoll tillsammans med inköpsbeviset till ditt inköpsställe. Endast om dessa dokument uppvisas kan vi garantera att reklamationen behandlas skyndsamt och utan krångel.

**Suomi:** Ostamasi tuote on valmistettu korkeita laatuvaatimuksia noudattaen, huolella tarkastettu ja pakattu. Jotta pystytys joko itsesi tai valitsemasi rakennusliikkeen toimesta sujuisi ongelmitta, suosittelimme, että tarkistat toimituksen sisällön osaluettelon avulla ennen kokoamisen aloittamista. Tämä tarkistus tulee tehdä 14 päivän kuluessa toimituksesta. Takuuvaateet rajoittuvat viallisten materiaalien vaihtamiseen. Viallisia osia, joita on jo käytetty ja jotka on maalattu, ei vaihdeta uusiin. Lisävaatimuksia ei huomioida! Mahdollisissa valitustapauksissa toimi seuraavasti: Esitä oheinen tarkastustodistus ja kassakuitti ostopaikassa. Valituksen nopea ja mutkaton käsittely edellyttää näiden asiakirjojen esittämistä.

<p><b>Dansk:</b> Det købte produkt fremstillet i overensstemmelse med de høje kvalitetskrav. Produktet er blevet omhyggeligt inspiceret og pakket. For at undgå eventuelle problemer i løbet af monteringen udført af dig selv eller håndværker af dit eget valg, anbefaler vi, at du undersøger leverancen for fuldstændighed i overensstemmelse med listen over dele før samling. Denne inspektion skal foretages inden 14 dage efter levering til din plads. Garantikrav er begrænset til udveksling af defekte materialer. Defekte produkter, som allerede er brugt eller malet, er udelukket fra at blive erstattet. Alle yderligere krav er udelukket! I tilfælde af klager, skal du være opmærksom på følgende procedurer: Venligst præsenterer denne kontrolcertifikat sammen med kvitteringen til det sted hvor produktet er købt. Kun i de tilfælde, hvor disse dokumenter er forelagt kan klagen behandles hurtigt og uden komplikationer.</p>
<p><b>Dutch:</b> Het door U gekochte product werd vervaardigd overeenkomstig hoge kwaliteitsnormen. Het product werd zorgvuldig gecontroleerd en verpakt. Om tijdens de montage, uitgevoerd door Uzelf of een door U gekozen aannemer, problemen te vermijden, raden we U aan, vóór de montage de levering te controleren op volledigheid in overeenstemming met de onderdelenlijst. Deze controle dient te gebeuren binnen 14 dagen na levering bij U thuis. Garantieclaims zijn beperkt tot het vervangen van defecte onderdelen. Defecte onderdelen die al gebruikt of geschilderd zijn, zijn uitgesloten van vervanging. Alle latere claims zijn uitgesloten! In geval van klachten dient u als volgt te handelen: Toon dit controlecertificaat, samen met Uw aankoopbewijs aan Uw verkoper. Alleen wanneer deze documenten getoond worden, zal de klacht snel en zonder complicaties in behandeling worden genomen.</p>
<p><b>Português:</b> O produto que comprou foi fabricado em conformidade com as normas de alta qualidade. A unidade do produto foi cuidadosamente inspecionada e embalada. Para evitar possíveis problemas durante a montagem realizada por si ou pela empresa de construção à sua escolha, recomendamos que inspecione a entrega na íntegra, em conformidade com a lista de peças antes da montagem. Esta inspeção deve ser realizada no prazo de 14 dias após a entrega. As reclamações de garantia limitam-se à troca de materiais defeituosos. As peças do produto com defeito, que já tenham sido utilizadas ou pintadas, excluem-se da substituição. Excluem-se todas as outras reclamações! Em caso de reclamações, por favor, tome atenção aos seguintes procedimentos: Por favor, apresente este certificado de inspeção, juntamente com o recibo de venda no seu local de compra. Apenas nos casos em que estes documentos sejam apresentados a queixa será tratada com rapidez e sem complicações.</p>
<p><b>Čeština:</b> Produkt, který jste zakoupil, byl vyroben v souladu s normami stanovujícími vysokou kvalitu. Produkt byl výrobcem pečlivě prohlédnutý a zabaleny. Aby se předešlo možným problémům při montáži prováděné svépomocí nebo stavební firmou dle vašeho výběru, doporučujeme vám před montáží zkontrolovat dodávku na úplnost v souladu se seznamem dílů. Tato prohlídka musí být provedena do 14 dnů (!) od doručení do místa určení. Záruční nároky jsou omezeny na výměnu vadných materiálů. Vadné produkty, které již byly použity nebo které jsou již opatřeny nátěrem, nemohou být nahrazeny. Všechny další nároky jsou vyloučeny! V případě reklamace věnujte prosím pozornost tomuto postupu: Předložte svému prodejci tento kontrolní certifikát spolu s prodejním dokladem. Pouze v případě, kdy jsou předloženy oba tyto dokumenty, lze reklamaci řešit rychle a bez komplikací.</p>
<p><b>Polski:</b> Produkt, który Państwo zakupili, wykonano według najwyższych norm jakości. Elementy konstrukcyjne przed zapakowaniem przeszły dokładną kontrolę jakości. Aby uniknąć problemów podczas samodzielnego montażu, bądź montażu zleconego firmie budowlanej, przed montażem zalecamy sprawdzenie zawartości przesyłki zgodnie z listą części zamieszczonych w zestawie. Kontrola kompletności zestawu należy dokonać w ciągu 14 dni od dostarczenia przesyłki. Reklamacje objęte gwarancją ograniczają się do wymiany wadliwych elementów. Wadliwe elementy, które zostały użyte lub pomalowane nie będą podlegały wymianie ani dalszym reklamacjom. W przypadku potrzeby zgłoszenia reklamacji, prosimy przestrzegać poniższych procedur: prosimy przedłożyć Certyfikat kontrolny wraz z paragonem zakupu i adresem dostawy. Reklamacje będą rozpatrywane wyłącznie po dostarczeniu powyższych dokumentów.</p>
<p><b>Lietuviškai:</b> Produktas, kurį įsigijote, pagamintas pagal aukštos kokybės standartus. Produkto blokas, kurį reikia surinkti, buvo atidžiai patikrintas ir supakuotas. Siekiant išvengti galimų problemų surenkant produktą patiems arba pasirinkus tam norimą statybos bendrovę, prieš surenkant rekomenduojame patikrinti pristatymo komplektaciją pagal dalių sąrašą. Ši patikra turi būti atlikta per 14 dienų nuo pristatymo į jūsų namus vietą. Garantinės sąlygos taikomos tik brokuotoms dalims. Brokuotos produkto dalys, kurios buvo panaudotos arba nudažytos, nebekeičiamos. Visos kitos pretenzijos nesvarstomos! Jei teikiate pretenziją, atkreipkite dėmesį į šias procedūras: į produkto įsigijimo vietą turite pristatyti apžiūros pažymėjimą bei pirkimo kvitą. Tik tais atvejais, kai pristatomi minėti dokumentai, pretenzija gali būti nagrinėjama greitai ir be komplikacijų.</p>
<p><b>Latviešu:</b> Produkts, kuru esat iegādājies, ir ražota saskaņā ar augstām kvalitātes normām. Šī produkta vienība ir rūpīgi pārbaudīta un iepakota. Lai izvairītos no iespējamiem sarežģījumiem montāžas laikā, kuru veicat jūs pats vai jūsu izvēlēts celtniecības uzņēmums, pirms montāžas iesakām pārbaudīt, vai piegādātajam izstrādājumam nekas netrūkst, izmantojot detaļu sarakstu. Šī pārbaude jāveic 14 dienu laikā pēc piegādāšanas. Garantija paredz tikai defektīvo materiālu apmaiņu. Defektīvas produkta detaļas, kuras jau ir izmantotas vai nokrāsotas, netiks mainītas. Visas turpmākās pretenzijas tiks noraidītas! Sūdzību gadījumā, lūdzu, ievērojiet šādu kārtību: lūdzu, uzrādiet šo pārbaudes aktu kopā ar pirkuma čeku izstrādājuma iegādāšanās vietā. Sūdzība tiks atrisināta ātri un bez sarežģījumiem tikai tad, ja tiks uzrādīti šie dokumenti.</p>
<p><b>Русский:</b> Приобретенное вами изделие изготовлено по высоким стандартам качества. Изделие внимательно проверено и упаковано. Во избежание возможных проблем в процессе сборки, выполняемой самостоятельно или привлеченной вами строительной компанией, рекомендуем перед сборкой проверить комплектность поставки по комплектовочной ведомости. Такую проверку следует провести в течение 14 дней после доставки товара. Претензии по гарантии ограничиваются заменой дефектных материалов. Дефектные части изделия, которые уже были использованы или окрашены, замене не подлежат. Все прочие претензии не принимаются! Порядок подачи претензии: Претензия подается с настоящим актом осмотра и товарным чеком по месту покупки товара. Только при наличии всех указанных документов претензия будет рассмотрена быстро и без сложностей.</p>
<p><b>Eesti:</b> Ostetud toode on toodetud vastavuses kõrgete kvaliteedi normidega. Toote ühik on hoolikalt kontrollitud ja pakendatud. Et vältida võimalikke probleeme paigaldamisel, mida teostate ise või teostab teie poolt valitud paigaldusettevõte, soovime enne paigaldama asumist kontrollida toote kompleksust detailide nimekirja alusel, mille leiate kaasas olevast juhendist. See kontroll tuleb teostada 14 päeva jooksul pärast tarnet. Garantii alla kuuluvad kaebused on piiratud defektsete detailide välja vahetamisega. Defektsed detailid, mida on juba kasutatud või värvitud, ei kuulu garantiikorras välja vahetamisele. Kõik edasised kaebused on välistatud! Kaebuste korral palun pöörake tähelepanu järgnevale: palun hoidke see kontrollakt koos müügiarvega alles. Ainult nende dokumentide esitamisel lahendatakse kaebused kiiresti ja ilma komplikatsioonideta.</p>

**The producer shall have the right to make technical changes to the product.** • Technische Änderungen vorbehalten. • Le producteur réserve le droit d'effectuer des modifications techniques au produit. • Reservado el derecho a modificaciones técnicas. • Il produttore mantiene il diritto di apportare modifiche tecniche al prodotto. • Producent forbeholder seg retten til å endre tekniske egenskaper ved produktet. • Tillverkaren har rätt att utföra tekniska förändringar för produkten. • Valmistaja pidättää oikeuden tehdä tuoteeseen teknisiä muutoksia. • Producenten har ret til at foretage tekniske ændringer ved produktet. • Alle rechten en technische wijzigingen voorbehouden. • O fabricante reserva-se o direito de realizar alterações técnicas ao produto. • Výrobce je oprávněn provádět technické úpravy produktu. • Producent zastrzega sobie prawo do dokonywania zmian technicznych produktu. • Gamintojas turi teisę atlikti techninius gaminio pakeitimus. • Ražotājs patur tiesības veikt tehniskas produkta izmaiņas. • Производитель оставляет за собой право вносить в изделие технические изменения. • Tootja jätab endale õiguse muuta toote tehnilisi omadusi.



# Installation manual

Montageanleitung • Notice de montage • Istruzioni per il montaggio • Manual de montaje •  
Asennusohje • Installationsmanual

## Pavilion PA28-2929-2

Pavillon • Pavillon • Padiglione • Pabellón • Paviljonki • Paviljong

Diameter Ø 285 cm

Durchmesser • Diamètre • Diametro • Diámetro • Koko • Diameter

Log thickness 28 mm

Bohlenstärke • Épaisseur des murs • Spessore delle pareti • Grosor de pared • Seinän paksuus •  
Väggjocklek



The producer shall have the right to make technical changes to the product • Technische Änderungen vorbehalten • Le producteur réserve le droit d'effectuer des modifications techniques au produit • Il produttore mantiene il diritto di apportare modifiche tecniche al prodotto • Reservado el derecho a modificaciones técnicas • Valmistaja pidättää oikeuden tehdä tuotteeseen teknisiä muutoksia • Tillverkaren har rätt att utföra tekniska förändringar för produkten

## I. Generelles



### **Sehr geehrter Kunde,**

es freut uns, dass Sie sich für unser Gartenhaus entschieden haben!

**Es ist wichtig, diese Aufbauanleitung vollständig durchzulesen, bevor Sie mit dem Aufbau Ihres Blockhauses beginnen!** So vermeiden Sie Probleme und unnötigen Zeitverlust.

#### **Tipps:**

- Lagern Sie den Bausatz bis zur endgültigen Montage trocken und nicht direkt auf dem Erdboden, geschützt vor Witterungseinflüssen (Nässe, Sonneneinwirkung, etc.). Ware bitte nicht in einem geheizten Raum aufbewahren!
- Achten Sie bei der Standortwahl darauf, dass das Blockhaus nicht extremen Witterungsbedingungen (Gebiete mit starkem Wind) ausgesetzt ist, gegebenenfalls sollten Sie das Blockhaus zusätzlich mit dem Fundament verankern.



### **Gewährleistung**

Ihr Haus besteht aus hochwertigem nordischen Fichtenholz und wird unbehandelt geliefert. Wenn es trotz unserer sorgfältigen Werkskontrolle zu Reklamationen kommen sollte, legen Sie Ihrem Fachhändler den ausgefüllten Kontrollschein mit Ihrer Einkaufsrechnung vor!

**WICHTIG: Bitte unbedingt die Dokumentation aufbewahren! Auf dem Kontrollschein finden Sie die Kontrollnummer des Hauses. Es ist möglich die Reklamation nur dann als Garantiefall zu behandeln, wenn Sie die Kontrollnummer Ihrem Fachhändler weitergeben!**

Abweichungen die keinen Reklamationsgrund darstellen:

- Holz ist ein Naturprodukt, daher gehören die naturgegebenen Beanstandungen nicht unter Garantie.
- Materialreklamationen werden nicht akzeptiert, wenn bereits ein Anstrich erfolgte!
- Äste die mit dem Holz fest verwachsen sind.
- Holzverfärbungen, ohne das dadurch die Lebensdauer beeinflusst wird.
- Risse /Trockenrisse die nicht durchgehend sind und nicht die Konstruktion beeinflussen.
- Verdrehungen des Holzes vorausgesetzt es lässt sich noch verarbeiten.
- An den nicht sichtbaren Seiten von Dach- und Fussbodenbrettern können die Bretter ungehobelt sein, es können Farbunterschiede und Baumkanten vorkommen.
- Spätere Reklamation durch unsachgemässe Montage, Absacken des Hauses durch unsachgemässe Fundamente und Gründungen sind ausgeschlossen.
- Eigene Veränderungen am Haus wie z.B. Verzug von Bohlen und Fenstern/Türen durch fehlenden Holzanstrich oder Aufbau, die zu starre Befestigung der Sturmleiste, Verschrauben der Türrahmen mit den Blockbohlen usw., sind ausgeschlossen.

**Ansprüche auf Gewährleistung beschränken sich auf den Austausch von fehlerhaftem Material. Alle weiteren Ansprüche sind ausgeschlossen!**



## Anstrich und Pflege

Holz ist ein Naturprodukt und arbeitet unterschiedlich. Merkmale wie grobe und feine Maserungen, Farbschattierungen und Veränderungen sowie Verwachsungen haben Ihren Ursprung im Wuchs des Baumes. Sie sind bei Hölzern, die in der freien Natur wachsen, normal und deshalb nicht als Fehler, sondern vielmehr als Eigentümlichkeit des Naturwerkstoffes Holz anzusehen.

Das unbehandelte Holz (ausser Lagerhölzer) wird nach einiger Zeit vergrauen, kann verbläuen und verschimmeln. Um ihr Blockhaus zu schützen, sollten Sie es mit geeigneten Holzschutzmitteln behandeln.

Um Ihr Gartenhaus optimal zu schützen, empfehlen wir die Bodenbretter vorgängig mit einer farblosen Grundierung zu behandeln. Besonders die Unterseite, welche nach der Montage nicht mehr zu erreichen ist. Nur auf diese Weise wird das Eindringen der Feuchtigkeit verhindert.

Wir empfehlen unbedingt auch Türen und Fenster mit einer Grundierung zu behandeln. Es ist sehr wichtig sowohl die Innen- als auch die Aussenseiten der Türen und Fenster auf einmal zu streichen! Andernfalls können sie sich verziehen.

Nach dem Aufbau empfehlen wir Ihnen die Aussenhaut (ohne Dach) zu Grundieren, sobald diese trocken ist sollten Sie das Haus mit einer Holzlasur streichen, die das Holz vor Feuchtigkeit und UV-Strahlung schützt.

Beim Anstrich benutzen Sie hochwertiges Werkzeug und Farbe, beachten Sie die Sicherheits- und Verarbeitungshinweise des Farbenherstellers. Streichen Sie nie in praller Sonne oder beim regnerischen Wetter. Lassen Sie sich ausführlich bei Ihrem Fachhändler über den Holzschutz für unbehandelte Nadelhölzer beraten.

Durch einen regelmässigen Anstrich beeinflussen Sie im Wesentlichen die Lebensdauer Ihres Gartenhauses. Wir empfehlen Ihnen auch eine halbjährliche Inspektion des Gartenhauses.

## II. Vorbereitung zur Aufbau

### Werkzeuge und Vorbereitung der Details

Beim Aufbau brauchen Sie Folgendes:



Montagehelfer



Stehleiter



Hammer



Wasserwaage



Schraubenzieher



Säge



Messer



Bandmass



Zange



Bohrer

**HINWEIS:** Um Verletzungen durch eventuelle Holzsplitter zu vermeiden, tragen Sie bitte während der Montage entsprechende Schutzhandschuhe.

## 1 General information



**Dear client,**

We are glad that you have decided in favour of our garden house!

**Please read the assembly manual carefully before proceeding with the house installation!** You will thus avoid problems and will not waste time.

### **Recommendations:**

- Keep the house package until its complete assembly in a dry place, but not in direct contact with the ground, protected from weather conditions (moisture, the sun, etc.). Do not keep the house package in a heated room!
- When selecting the garden house location, make sure that the house will not be subjected to extreme weather conditions (areas of strong snowfall or winds); otherwise you should attach the house (for instance, with anchors) to the subsoil.



### **Warranty**

Your house is made from high quality fir and delivered in the natural (unprocessed) form. If, despite our thorough inspection, you should have complaints, please submit the filled out control sheet and purchase invoice to the product seller.

**ATTENTION: Please be sure to keep the documentation accompanying the house package! The control sheet includes the control number of the house. We can only review complaints if you submit the control number of the house to the seller!**

The warranty does not cover:

- Peculiarities of wood as a natural material
- Wooden details already painted (processed with a wood preservative)
- Wooden details containing whole branches that do not endanger the stability of the house
- Colour tone variations caused by wood structure differences that do not influence wood lifetime
- Wooden details containing (caused by drying) small cracks/gaps that do not pass through and do not influence the structure of the house
- Twisted wooden details if they can nevertheless be installed
- Roof and floor boards that may have on their concealed surfaces some non-planed areas, colour differences and waning
- Complaints resulting from an incompetent manner of the installation of the house or the house subsiding due to an incompetently made foundation
- Complaints caused by introducing self-initiative changes to the house, such as the deformation of wooden details and doors/windows due to an incompetent manner of wood processing; the attachment of storm braces too rigidly, doorframes being screwed onto wall logs, etc.

**The complaints covered by the warranty are satisfied to the extent of replacing the deficient/faulty material. All other demands will be excluded!**



## Garden house painting and maintenance

Wood is a natural material, growing and adapting depending on weather conditions. Large and small cracks, colour tone differences and changes, as well as a changing structure of wood are not errors, but a result of wood growing and a peculiarity of wood as a natural material.

Unprocessed wood (except for foundation joists) becomes greyish after having been left untouched for a while, and can be turn blue and become mouldy. To protect the wooden details of your garden house, you must immediately process them with a wood preservative.

We recommend that you cover the floor boards in advance with a colourless wood impregnation agent, especially the bottom sides of the boards, to which you will no longer have access when the house is assembled. Only this will prevent moisture penetration.

We definitely recommend that you also process the doors and windows with a wood impregnation agent, and do that namely both inside and outside! Otherwise the doors and windows can become twisted.

After the house assembly is completed, we recommend for the conclusive finishing a weather protection paint that will protect wood from moisture and UV radiation.

When painting, use high quality tools and paints, follow the paint application manual and manufacturer's safety and usage instructions. Never paint a surface in strong sunlight or rainy weather. Consult a specialist regarding paints suitable for unprocessed softwood and follow the paint manufacturer's instructions.

Having been properly painted, your garden house's lifetime will increase substantially. We recommend that you inspect the house thoroughly once every six months.

## 2 Preparation for assembly

### Tools and preparation of components

To assemble the garden house, you will need the following tools:



assembly aid



ladder



hammer

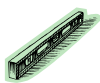

water-level



screwdriver



saw



knife



measuring tape



pliers



drill

**ADVICE:** To avoid splinters, we recommend that you wear the corresponding protective gloves during the assembly process.



## I. Généralités



**Cher client,**

Nous sommes heureux que votre choix se soit porté sur notre maison de jardin!

**Il est important de lire entièrement cette notice de montage avant de commencer la construction de votre maisonnette en poutres!** Vous vous éviterez ainsi des problèmes et des pertes de temps inutiles.

### **Conseils:**

- Avant son montage définitif, entreposez le kit de construction au sec et pas directement sur la terre, en le protégeant contre les intempéries (humidité, rayonnement du soleil, etc.). Ne pas conserver la marchandise dans un local chauffé!
- Au moment de choisir l'endroit de montage, veillez à ce que la maisonnette en poutres ne soit pas exposée à des conditions atmosphériques extrêmes (zones exposées à des vents forts). Le cas échéant, il serait bon d'ancrer la maisonnette en poutres dans des fondations.



### **Garantie**

Votre maisonnette est réalisée en bois d'épicéa nordique de haute qualité et elle vous est livrée non traitée. Si elle devait donner lieu à des réclamations, malgré les soins apportés à notre contrôle en usine, nous vous demandons de remettre à votre revendeur spécialisé le bon de contrôle rempli et votre facture d'achat!

**IMPORTANT: Veuillez impérativement conserver la documentation! Vous trouverez sur le bon de contrôle le numéro de contrôle de la maisonnette. La réclamation ne peut être traitée dans le cadre de la garantie que si vous communiquez le numéro de contrôle à votre revendeur spécialisé!**

Ecarts qui ne constituent pas un motif de réclamation:

- Le bois est un produit naturel, ce qui fait que les réclamations reposant sur des phénomènes naturels ne tombent pas sous le coup de la garantie.
- Les réclamations concernant les matériaux ne sont pas acceptées si une peinture a déjà été appliquée!
- Nœuds qui sont inhérents au bois.
- Décolorations du bois qui n'exercent pas d'influences sur la durée de vie.
- Fissures / fentes de retrait qui ne sont pas traversantes et qui n'exercent pas d'influences sur la construction.
- Déformations du bois, sous réserve qu'il puisse encore être mis en œuvre.
- Sur les faces non visibles des planches du toit et du plancher, il se peut que les planches ne soient pas rabotées, on peut observer des différences de couleur et des flaches.
- Une réclamation tardive résultant d'un montage incorrectement réalisé, d'un affaissement de la maisonnette par suite de fondations et de soubassements incorrectement réalisés, est exclue.
- Une réclamation suite à des modifications apportées de son propre chef à la maisonnette, comme par exemple une déformation des madriers et des fenêtres/portes par suite d'une peinture du bois ou d'une construction insuffisantes, la fixation trop rigide du contreventement, le vissage des dormants sur les madriers, etc., est exclue.

**Les recours en garantie se limitent au remplacement du matériel défectueux. Tous les autres recours sont exclus!**



### Peinture et entretien

Le bois est un produit naturel qui travaille de façon variable. Des caractéristiques telles que les madrures grossières et fines, les nuances de couleurs et les modifications, de même que les imbrications, ont leur origine dans la croissance du bois. Dans le cas de bois qui poussent en pleine nature, ces caractéristiques sont normales et ne doivent par conséquent pas être considérées comme des défauts mais, au contraire, comme une particularité de ce matériau naturel qu'est le bois.

Au bout de quelque temps, le bois non traité (à l'exception des longrines) prendra une teinte grise, il pourra bleuir et moisir. Pour protéger votre maisonnette en poutres, il convient que vous le traitiez avec des produits de protection du bois appropriés.

Pour protéger votre maison de jardin de façon optimale, nous vous conseillons de traiter préalablement les planches du plancher à l'aide d'un apprêt incolore. En particulier la face inférieure à laquelle vous ne pourrez plus avoir accès après le montage. Ce n'est que de cette façon que l'on empêche l'humidité de pénétrer.

Nous conseillons de traiter impérativement les portes et les fenêtres également à l'aide d'un apprêt. Il est très important de peindre en une seule fois aussi bien les faces intérieures que les faces extérieures des portes et des fenêtres! Dans le cas contraire, elles pourront se déformer.

Une fois le montage effectué, nous vous conseillons de revêtir l'extérieur (sans le toit) d'un apprêt. Dès que cet apprêt sera sec, vous devrez revêtir votre maison d'un glacis pour bois qui protégera le bois contre l'humidité et le rayonnement ultraviolet.

Pour la peinture, n'utilisez qu'un outillage et une peinture de haute qualité, et respectez les consignes de sécurité et de mise en œuvre du fabricant de peintures. Ne peignez jamais en plein soleil ou lorsque le temps est à la pluie. Faites-vous conseiller de façon détaillée par votre revendeur spécialisé quant à la protection à utiliser pour les conifères non traités.

En refaisant régulièrement la peinture, vous augmentez sensiblement la durée de vie de votre maison de jardin. Nous vous conseillons également une inspection semestrielle de votre maison de jardin.

## II. Préparation au montage

### Outils et préparation des détails

Pour le montage, vous avez besoin du matériel suivant:



une personne pour vous aider au montage



échelle double



marteau



niveau à bulle d'air



tournevis



scie



couteau



mètre-ruban



pince



foret

**REMARQUE:** Pour éviter les blessures provoquées par d'éventuels éclats de bois, nous vous demandons de porter des gants de protection correspondants lors du montage.

## I. In generale



**Gentile Cliente,**

siamo veramente lieti che Lei abbia scelto la nostra casetta di legno per il Suo giardino!

**E' importante leggere accuratamente le istruzioni prima di iniziare con il montaggio della Sua casetta di legno!** In tal modo eviterà qualsiasi problema e perdita di tempo.

### **Consigli:**

- Conservare il kit in luogo asciutto e non direttamente sul pavimento, protetto da agenti atmosferici (acqua, sole ecc.) fino al montaggio definitivo. Non conservare il prodotto in ambienti riscaldati !
- Nella scelta del luogo di collocamento, fare attenzione che la casetta non sia esposta a condizioni atmosferiche estreme (vento forte); eventualmente ancorare la casetta ulteriormente con le fondamenta.



### **Garanzia**

La vostra casetta è stata realizzata con pregiato legno di abete rosso nordico e viene consegnata in stato non trattato. Qualora, nonostante il nostro accurato controllo in fabbrica, dovessero sorgere reclami, sarà necessario presentare al negoziante il certificato di controllo compilato insieme alla fattura d'acquisto!

**IMPORTANTE: E' assolutamente necessario conservare la documentazione! Sul certificato di controllo è riportato il numero di controllo della casa. Reclami possono essere evasi in garanzia unicamente se comunicherete il numero di controllo al vostro negoziante!**

### Divergenze che escludono motivo di reclamo:

- Il legno è un prodotto naturale e pertanto le contestazioni relative allo stato naturale non rientrano nella garanzia.
- Reclami relativi al materiale non vengono accettati una volta verniciato!
- Rami cresciuti nel legno.
- Scolorimenti del legno che non influiscono sulla durata.
- Crepe /fessure non passanti che non compromettono la costruzione.
- Nodi nel legno a condizioni che possa ancora essere lavorato.
- Nei punti invisibili del tavolame tetto e pavimento sono ammesse tavole non piallate; sono inoltre ammesse differenze di colore e spigoli dell'albero.
- Reclami successivi dovuti a montaggio non conforme, cedimento della casetta a causa di fondamenta errate sono esclusi.
- I reclami causati introducendo modifiche proprie alla casetta, p.es. deformazione di tavole e finestre/porte dovute ad un montaggio incompetente, fissaggio troppo rigido del listello antivento, avvitarmento dei telai delle porte con le tavole di legno ecc., sono esclusi.

**Le rivendicazioni di garanzia sono limitate alla sostituzione del materiale difettoso. Ogni altra rivendicazione è esclusa!**



### Verniciatura e cura

Il legno è un prodotto naturale e si muove in modo diverso. Caratteristiche quali venature grosse e fini, sfumature di colore e cambiamenti nonché nodi sono dovuti alla crescita dell'albero. Sono del tutto normali nei legni che crescono all'aperto, e pertanto non sono da considerare difetti ma piuttosto una caratteristica del legno naturale.

Il legno non trattato (ad eccezione dei travetti) diventa grigio col tempo, può scolorirsi e fare la muffa. Per proteggere la vostra casetta di legno, è consigliabile trattarla con opportuni preservanti per legno.

Per proteggere al meglio la vostra casetta da giardino, consigliamo di trattare le tavole del pavimento preventivamente con un colore di fondo neutro, in particolare la parte inferiore che non sarà più raggiungibile dopo il montaggio. Solo in questo modo la penetrazione di umidità potrà essere evitata.

Consigliamo di trattare in ogni caso anche porte e finestre con un colore di fondo. E' molto importante verniciare sia il lato interno che quello esterno delle porte in un'unica soluzione, altrimenti potrebbero deformarsi !

Dopo il montaggio, consigliamo di applicare uno strato di fondo sulla pelle esterna (senza tetto), non appena il medesimo si sarà asciugato, verniciare la casetta con una velatura per legno per proteggere il legno dall'umidità e dalle radiazioni UV.

Per la verniciatura, usare attrezzi e vernici di qualità e rispettare le istruzioni di sicurezza e applicazione del produttore della vernice. Non verniciare in pieno sole o in caso di pioggia. Farsi consigliare dettagliatamente dal venditore sulla protezione di legni di conifera non trattati.

Con una regolare verniciatura aumenterete notevolmente la durata della vostra casetta da giardino. Consigliamo un'ispezione semestrale della casetta.

## II. Preparazione al montaggio

### Attrezzi e preparazione dei particolari

#### Attrezzi occorrenti:



aiutante



scala doppia



martello



livella a bolla d'aria



cacciavite



sega



coltello



metro



pinza



trapano

**AVVERTENZA:** Per evitare lesioni causate da eventuali schegge di legno, portare guanti di protezione durante il montaggio.

## 1 Generell informasjon



**Kjære kunde,**

Vi er glade for at du bestemte deg for lysthuset vårt!

**Les monteringsveiledningen nøye før du setter i gang med monteringen!** Da unngår du problemer og kaster ikke bort tid.

### **Anbefalinger:**

- Oppbevar pakken med delene på et tørt sted til du har satt den opp ferdig. Pakken må beskyttes fra vær (fuktighet, sol osv.) og bør ikke være i direkte bakkekontakt under lagring. Ikke oppbevar pakken i et oppvarmet rom!
- Når du velger et sted å sette opp lysthuset, må du sørge for at byggverket ikke blir utsatt for ekstreme værforhold (mye snø eller vind); ellers må du feste lysthuset (med for eksempel anker) til underlaget.



### **Garanti**

Lysthuset ditt er laget av høykvalitetsgran og leveres i naturlig (ubehandlet) materiale (unntatt fundamentsbjelkene). Skulle du på tross av vår grundige inspisering ha klager, må du sende inn utfylt kontrollskjema og kjøpsfaktura til produktselgeren.

**MERK: Ta vare på inspeksjonssertifikatet! Kontrollskjemaet inneholder kontrollnummeret til lysthuset. Vi kan bare behandle klager dersom du sender inn kontrollnummeret på lysthuset til selgeren!**

### Garantien dekker ikke:

- Særlige egenskaper tre har som naturmateriale
- Tredeler som allerede er malt (behandlet med trebeskyttelsesmiddel)
- Tredeler med kvister som ikke truer stabiliteten til lysthuset.
- Fargetonevariasjon forårsaket av forskjeller i trestrukturen som ikke innvirker på levetiden til treet
- Tredeler med små tørkesprekker som ikke er gjennomgående.
- Vridde tredeler dersom de uansett kan monteres.
- Tak- og golvplanker som kan ha uhøvlede områder, fargeavvik og små skader på siden som ikke er synlig.
- Klager grunnet ukyndig oppsetting av lysthuset eller at lysthuset synker grunnet for svakt fundament.
- Klager grunnet egne endringer på lysthuset, slik som deformering av tredeler og dører/vinduer grunnet ukyndig montering, for fast festing av stormstag, dørkarmer som blir skrudd fast til veggstokker osv.

**Klager som dekkes av garantien blir oppfylt ved at manglende/mangelfullt materiale erstattes. Alle andre krav er utelukket.**



Tre er et naturmateriale som vokser og tilpasser seg værforholdene. Store og små sprekker, fargetonevariasjon og -endringer, i tillegg til endrende trestruktur er ikke feil, men et resultat av treveksten og særegenheter ved treet som naturmateriale.

Ubehandlet tre (unntatt fundamenteringsbjelkene) blir gråaktig etter å ha stått urørt en stund, og kan bli blått og mugne. For å beskytte tredelene til lysthuset må du straks behandle dem med trebeskyttelsesmiddel.

Vi anbefaler at du dekker gulvplankene på forhånd med et fargeløst treimpregneringsmiddel, særlig undersiden av plankene, der du ikke lenger får tilgang når bygget er oppsatt. Bare dette kan forhindre at fuktighet trenger inn.

Vi anbefaler absolutt at du også behandler dører og vinduer med et treimpregneringsmiddel, både på innsiden og utsiden! Ellers kan dører og vinduer bli skjeve.

Etter at lysthuset er ferdig oppsatt, anbefaler vi til slutt en værbeskyttende maling som beskytter treet fra fuktighet og UV-stråling.

Når du maler må du bruke verktøy og maling av høy kvalitet, følge bruksanvisningen for malingen og produsentens sikkerhetsinstruksjoner. Mal aldri en overflate i sterkt solskinn eller regnvær. Rådfør deg med spesialist om maling som passer til ubehandlet gran, og følg instruksjonene fra malingsprodusenten.

Riktig malt vil levetiden til lysthuset øke betraktelig. Vi anbefaler deg å kontrollere nøye hver sjette måned.

## 2 Forberedelse til oppsetting

### Verktøy og forberedelse av delene

Når du skal sette opp lysthuset trenger du disse verktøyene:



Monteringsveiledningen



Stige



Hammer

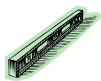

Vater



Skrutrekker



Sag



Kniv



Målestokk



Tang



Drill

**TIPS:** For å unngå fliser anbefaler vi deg å bruke vernehansker under oppsettingen.

## 1 Información general



### Estimado cliente,

¡Nos alegra que haya elegido una casita nuestra!

**¡Por favor, lea atentamente estas instrucciones de montaje antes de empezar el montaje de la casita de jardín!** Esto le ahorrará problemas y pérdida de tiempo.

#### Consejos:

- Preserve los elementos empaquetados hasta su ensamblaje completo en condiciones secas evitando el contacto directo con el suelo, y pretéjalas contra las condiciones meteorológicas adversas (humedad, luz solar, etc.) ¡No las mantenga en una habitación con altas temperaturas!
- Durante la elección de la ubicación de la cabaña en su jardín, no escoja un lugar donde la cabaña quede expuesta a condiciones climáticas extremas (zonas de fuertes nevadas o vientos fuertes), en caso contrario será necesario sujetar su cabaña (por ejemplo, con anclajes) al subsuelo.



### Garantía

Su casita esta hecha de madera de abeto de alta calidad y se entregará en estado natural (rugoso). Si, a pesar de nuestras inspecciones minuciosas, se encontrará con defectos, presente al vendedor un listado completo de **verificación** y el recibo al vendedor.

**ATENCIÓN: ¡Por favor, conservar la documentación relativa a la cabaña! El número de control de la casita se encuentra en el listado de verificación. ¡Sus quejas pueden ser consideradas solamente si usted suministra al vendedor el número de control de su casita de madera!**

#### La garantía no cubre:

- Características peculiares de la madera derivadas de la misma como un material natural
- Elementos que ya han sido pintados (madera tratada con conservantes de la madera)
- Elementos que contienen ramas sanas que no afectan la estabilidad de una casita
- Diferentes tonos de color debido a las variedades estructurales de la madera que no afectan la esperanza de vida de la madera
- Elementos con pequeñas grietas / divisiones (causadas por el secado) que no son penetrantes y no afectan a la construcción de la casita
- Elementos torcidos de madera si pueden ser instalados todavía
- Tableros de techo y suelo con superficie (oculta) rugosa, variaciones de color, y disminución
- Quejas provocadas por un montaje incompetente de la casita o asentamientos de la casita debidos a fallos de la construcción de los cimientos
- Quejas causadas por alteraciones no autorizadas hechas en la cabaña, tales como el doblado de los elementos de madera o de las ventanas / puertas como consecuencia del incompetente trato de la madera, de la excesivamente rígida fijación de las tablas de acceso o atornillado de los marcos de las puertas a los elementos de las paredes, etc.

**La satisfacción de las reclamaciones cubiertas por la garantía, se limita al intercambio de los materiales desaparecidos / defectuosos. ¡Todas las demás exigencias están excluidas!**



## Pintura y mantenimiento de la cabaña

La madera es un material natural que crece y se contrae debido a las condiciones climáticas. Grietas más pequeñas o más grandes, diferencias y cambios en los matices de colores y sus alternancias estructurales no son fallos, sino los resultados del crecimiento y de la peculiaridad de la madera como un material natural.

Con el tiempo la madera rugosa (excluyendo las vigas de la cimentación) cambia de color a gris o puede adoptar un color azul y enmohecer. Con el fin de proteger los elementos de su cabaña, deben ser tratados de inmediato con un conservante de madera.

Le recomendamos que cubra los suelos, especialmente sus partes inferiores, adonde no se puede llegar después del montaje de la cabaña, primero con un conservante incoloro de madera. Sólo de esta manera las tablas pueden protegerse de la penetración de la humedad.

También recomendamos que cubra las puertas y ventanas con conservantes de madera. Es esencial hacer el tratamiento tanto por dentro como por fuera de las superficies de las puertas y ventanas. En caso contrario, se pueden desarrollar deformaciones.

Después del ensamblaje de la cabaña, recomendamos para su acabado el uso de pintura resistente al agua para que proteja la madera contra la humedad y la radiación UV.

Para el acabado de su cabaña utilice únicamente herramientas y pinturas de alta calidad. Además, siga los manuales de instrucciones para las pinturas y las advertencias de seguridad y las instrucciones de uso proporcionadas por el fabricante. No pintar durante una luz intensa del sol o bajo la lluvia. Consulte a un experto en relación a las pinturas para madera áspera de coníferas y siga las instrucciones del fabricante de la pintura.

Frecuente pintura extiende considerablemente la vida útil de su cabaña. Recomendamos una cuidadosa inspección de la cabaña dos veces al año.

## 2 Preparativos para el montaje

### Herramientas y la preparación de los elementos

Para montar la cabaña, necesita lo siguiente:



Auxiliar de trabajo



Escalera



Martillo

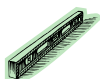

Instrumento de nivelación



Destornillador



Sierra



Cuchillo



Metro



Tenazas



Taladro

**Consejo:** Con el fin de defenderse de las astillas, durante el montaje se recomienda llevar guantes de protección.



## 1 Yleistä tietoa



**Hyvä asiakas,**

Olemme iloisia, että valintasi kohdistui tuotteeseemme!

**Ole hyvä ja lue kokoamisohje huolellisesti ennen pystytyksen aloittamista!** Tämä auttaa välttämään ongelmia ja säästää aikaa.

### **Suosituksia:**

- Säilytä pystytystä odottava mökkipaketti kuivassa paikassa, joka ei ole suorassa kosketuksessa maan kanssa, ja säältä suojassa (kosteus, aurinko jne.). Älä pidä pakettia lämmitetyssä tilassa!
- Valitessasi mökille paikkaa varmista, ettei se tule joutumaan alttiiksi äärimmäisille sääoloille (voimakkaalle lumentulolle tai koviin tuulille); muuten se tulee kiinnittää (esim. ankkureilla) maaperään.



### **Takuu**

Mökkisi on valmistettu korkealuokkaisesta kuusesta ja toimitetaan luonnollisessa (käsittelemättömässä) muodossa. Mikäli perusteellisesta tarkastuksestamme huolimatta sinulla on tuotteesta huomautettavaa, ole hyvä ja toimita täytetty valvontailmoitus ja ostolasku tuotteen myyjälle.

**HUOM! Muista säilyttää mökkipaketin mukana tulevat asiakirjat! Valvontailmoituksessa on tuotteen valvontanumero. Mahdollisten valitusten käsittely edellyttää, että mökin valvontanumero ilmoitetaan myyjälle!**

Takuu ei kata seuraavia:

- Puun erikoispiirteet luonnonmateriaalina
- Puuosat, jotka on jo maalattu (käsitelty kyllästysaineella)
- Puuosien oksakohdat silloin, kun ne eivät vaaranna mökin vakautta
- Puun rakenteesta johtuvat sävyerot, jotka eivät vaikuta puun kestävyteen
- Puuosissa olevat (kuivumisen aiheuttamat) pienet halkeamat/raot, jotka eivät mene puun läpi, eivätkä vaikuta talon rakenteeseen
- Taipuneet puosat, jotka voidaan kaikesta huolimatta asentaa
- Katto- ja lattialaudat, joiden piiloon jäävällä puolella saattaa olla höyläämättömiä kohtia, värieroja tai vajasärmä
- Valitukset, jotka johtuvat mökin virheellisestä pystytyksestä tai puutteellisen perustuksen aiheuttamasta vajoamisesta
- Valitukset, jotka johtuvat mökkiin oma-aloitteisesti tehdyistä muutoksista, kuten taitamattomasta käsittelystä johtuva puuosien ja ovien/ikkunoiden vääntyminen; jäykisteiden liian tiukka asentaminen, ovenkarmien ruuvaaminen seinäpuihin yms.

**Takuun piiriin kuuluvat huomautukset hoidetaan vaihtamalla viallinen/väärä materiaali uuteen. Muita mahdollisia vaateita ei huomioida!**



## Mökin maalaaminen ja huolto

Puu on luonnonmateriaali, joka laajenee ja elää sääolojen mukaan. Pienet ja suuret raot, värisävyerot ja -muutokset sekä puun rakenteen vaihtelu eivät ole virheitä, vaan ne johtuvat puun laajenemisesta ja luonnonmateriaalin ominaisuuksista.

Käsittelemätön puu (lattiapalkkeja lukuun ottamatta) muuttuu ajan myötä harmahtavaksi, ja saattaa sinertyä ja homehtua. Tämän vuoksi mökin puuosat tulee välittömästi suojata kyllästysaineella.

Lattialaudat kannattaa käsitellä etukäteen värittömällä puunkyllästysaineella, etenkin lautojen alapinnat, joihin ei pääse käsiksi enää mökin pystytyksen jälkeen. Se on ainoa keino estää kosteutta imeytymästä puuhun.

Myös ovet ja ikkunat tulee käsitellä kyllästysaineella niin sisä- kuin ulkopuolelta! Muuten on vaara, että ovet ja ikkunat vääntyvät.

Mökin pystytyksen jälkeen se kannattaa käsitellä kauttaaltaan sään vaikutuksilta suojaavalla maalilla, joka suojaa puuta kosteudelta ja UV-säteilyltä.

Maalatessa käytä laadukkaita työvälineitä ja maaleja, noudata maalausohjetta sekä valmistajan turvallisuus- ja käyttöohjeita. Älä koskaan maalaa suorassa auringonpaisteessa tai sateella. Kysy asiantuntijalta käsittelemättömälle havupuulle sopivista maaleista ja noudata maalinvalmistajan ohjeita.

Asianmukainen maalaus pidentää rakennuksen käyttöikää huomattavasti. Suosittelemme, että tarkastat mökin huolellisesti joka kuuden kuukauden välein.

## 2 Pystytyksen valmistelu

### Työkalut ja osien valmistelu

Mökin pystyttämisessä tarvitaan seuraavia työkaluja:



apulainen



tikkaat



vasara



vatupassi



ruuvimeisseli



saha



veitsi



rullamitta



pihdit



pora

**NEUVU:** Tikkujen välttämiseksi käytä asianmukaisia suojakäsineitä kokoamisen aikana.



**Toivotamme menestystä mökin kokoamisessa ja kosolti iloa sen parissa tulevina vuosina!**

## 1 Allmän information



**Bäste kund,**

Vi är glada för att du valt att skaffa ett trädgårdshus från oss!

**Vänligen läs monteringsanvisningarna noggrant innan du påbörjar monteringen av huset!** Du undviker därigenom problem och spillar ingen tid.

### Rekommendationer:

- Förvara husets förpackning, tills det är färdigmonterat, på en torr plats, men inte i direkt kontakt med marken, skyddad från väder och vind (fukt, solljus, etc.). Förvara inte husets förpackning i ett uppvärmt utrymme!
- När du väljer plats för trädgårdshuset, försäkra dig om att huset inte utsätts för extrema väderförhållanden (områden med kraftigt snöfall eller vindar); i så fall bör du förankra huset (till exempel med jordankare) i marken.



### Garanti

Ditt hus är tillverkat av gran av hög kvalitet och levereras i naturlig (obehandlad) form. Om du, trots vår noggranna besiktning, skulle ha några reklamationer, vänligen skicka den ifyllda kontrollblanketten och inköpsbeviset till vår återförsäljare.

**SE UPP! Vänligen se till att behålla dokumentationen tillsammans med husets förpackning! Kontrollblanketten innehåller husets kontrollnummer. Vi kan enbart granska reklamationer om du skickar med husets kontrollnummer till återförsäljaren!**

### Garantin omfattar inte:

- Egenheter för trä som ett naturmaterial.
- Redan målade trädetaljer (behandlade med träskyddsmedel)
- Trädetaljer som innehåller hela kvistar som inte äventyrar husets stabilitet
- Variationer i färgton orsakade av olikheter i träets struktur som inte påverkar träets livslängd
- Trädetaljer som innehåller mindre sprickor/spalter (orsakade av torkning) som inte är genomgående och inte påverkar husets konstruktion
- Skeva trädetaljer som ändå går att montera
- Tak och golvbrädor som på sina dolda ytor kan ha vissa ohyvlade områden, färgskiftningar och - mattning
- Reklamationer på grund av oskicklig montering av huset eller sättningskador på grund av en felaktigt uppförd grund
- Reklamationer orsakade av egna ändringar av huset, så som deformation av trädetaljer och dörrar/fönster på grund av ett oskickligt tillvägagångssätt vid montering av trädetaljer; fastsättning av stormbeslag för styvt, dörrkarmar som skruvas i väggreglar, mm.

**Reklamationer som omfattas av garantin tillgodoses i den omfattningen att det bristfälliga/felaktiga materialet ersätts. Alla andra anspråk lämnas utan åtgärd!**



## Målning och underhåll av trädgårdshus

Trä är ett naturmaterial som växer och anpassar sig efter väderförhållanden. Större och mindre sprickor, förändringar och skiftningar i färgton, samt även förändringar i träets struktur är inte felaktigheter, utan ett resultat av träets tillväxt och egenheter för trä som ett naturmaterial.

Obehandlat trä (undantaget grundsyllar) blir gråaktiga efter att ha lämnats orörda ett tag, de kan bli blå och börja mögla. För att skydda trädetaljer på ditt trädgårdshus måste du omedelbart behandla dem med träskyddsmedel.

Vi rekommenderar att du i förväg täcker golvbrädorna med ett färglöst träimpregneringsmedel, i synnerhet brädornas undersidor vilka du senare inte kommer åt när huset väl är monterat. Endast detta förebygger fuktinträning.

Vi rekommenderar definitivt att du även behandlar dörrar och fönster med ett bra impregneringsmedel och gör det både på in- och utsidan! Annars kan dörrar och fönster bli skeva.

Efter att huset är färdigmonterat, rekommenderar vi att slutbehandla det med en väderbeständig färg som skyddar träet från fukt och UV-strålning.

Använd redskap och färg av bra kvalitet vid målningen, följ användaranvisningen för färgen samt tillverkarens säkerhets- och användarinstruktioner. Måla aldrig en yta i starkt solljus eller vid regnväder. Rådgör med en specialist om färger som lämpar sig för obehandlat barrträ och följ färgtillverkarens anvisningar.

Husets livslängd förlängs avsevärt om det målas på rätt sätt. Vi rekommenderar att du besiktigar huset noggrant var sjätte månad.

## 2 Monteringsförberedelser

### Verktyg och förberedelse av komponenter

För att montera trädgårdshuset behöver du följande verktyg:



monteringshjälp



stege



hammare



vattenpass



skruvmejsel



såg



kniv



måttband



tång











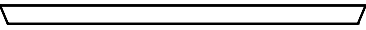
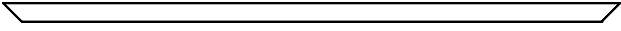
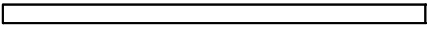
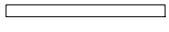

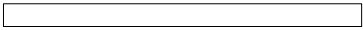

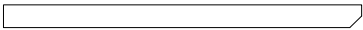

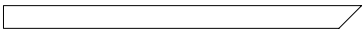
borr

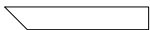







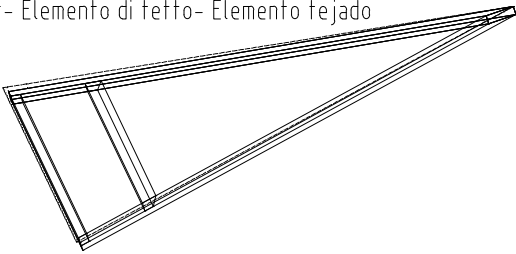
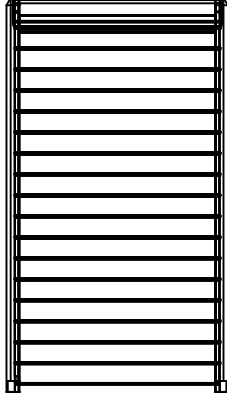
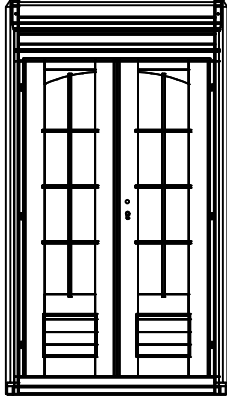
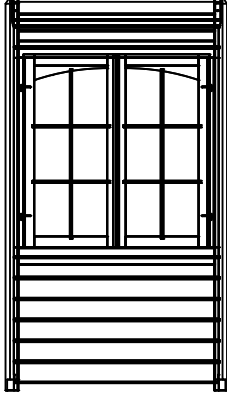
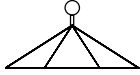
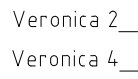

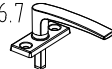

**RÅD:** För att undvika att få stickor, rekommenderar vi att du använder arbetshandskar under monteringen.



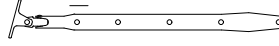





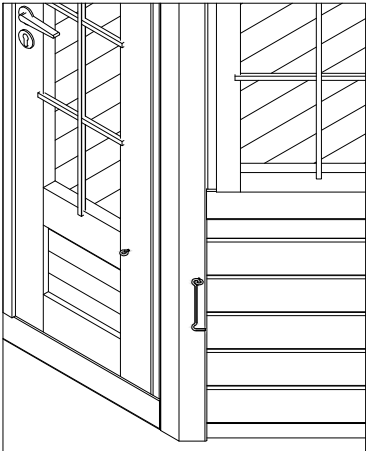

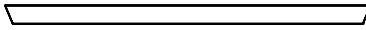
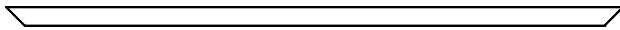
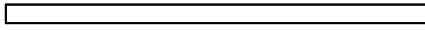
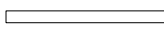

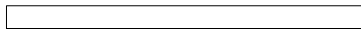



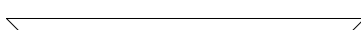

**Vi önskar dig lycka till med monteringen av trädgårdshuset och mycket glädje i många år framåt!**

Pos	SPECIFICATION - STÜCKLISTE - NOMENCLATURE - ELEMENTI "PAP28-2929"/"PA28-2929-1"	Pcs	Profile (mm)	Length (mm)
1	Foundation- Fundament- Fondation- Fondazione- Vigas de cimentación 	8	45x70	1185
2	Foundation- Fundament- Fondation- Fondazione- Vigas de cimentación 	2	45x70	1994
3	Foundation- Fundament- Fondation- Fondazione- Vigas de cimentación 	6	45x70	1360
4	Foundation- Fundament- Fondation- Fondazione- Vigas de cimentación 	3	45x45	600
5	Floor board- Fussbodenbrett- Madrier du plancher - Tavola pavimento- Tabla de suelo 			
5.1		13	19x89	1959
5.2		13	19x89	902
5.3		2	19x89	1959
5.4		2	19x89	902
5.5		2	19x89	1884
5.6		2	19x89	827
5.7		2	19x89	1795
5.8		2	19x89	738
5.9		2	19x89	2355
5.10		2	19x89	2177
5.11		2	19x89	1999
5.12		2	19x89	1821
5.13		2	19x89	1643
5.14		2	19x89	1465
5.15		2	19x89	1287
6	Fitting slat- Montagebrett- Tableau de montage- Tavola di montaggio- Tabla de montaje 	3	6x12	1200
7	Floor beading- Fussbodenleiste- Baguette du plancher - Listello pavimento- Listón de suelo 	7	19x40	1075
8	Wall batten- Wandleiste- Baguette du mur - Listello di muro- Liston de pared 	8+8	19x65	2056
9	Roof support brace- Dachstützleiste- Baguette de support de toit - Listello supporto tetto- Listón soporte tejado 	8	19x95	1075
10	Eave edging- Dachrandbrett- Madrier en bordure du toit - Tavola bordo tetto- Tabla de valadizo 	8	19x95	1482









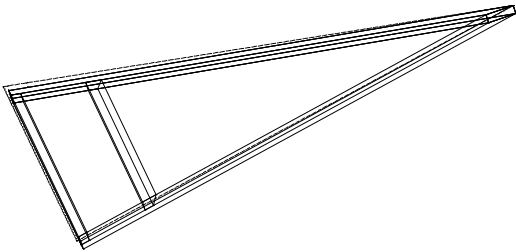
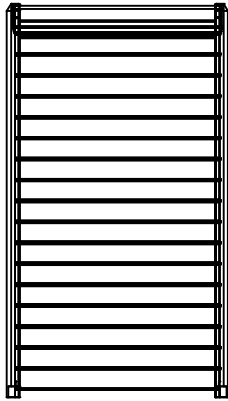
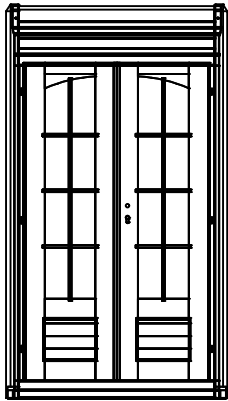
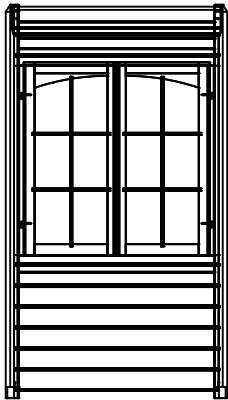
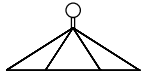

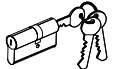
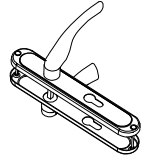
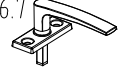

Pos	SPECIFICATION - STÜCKLISTE - NOMENCLATURE - ELEMENTI "PAP28-2929"/"PA28-2929-1"	Pcs	Profile (mm)	Length (mm)
11	Roof element- Dachelement- Panneau de toit- Elemento di tetto- Elemento tejado 	8	61x1441	2185
12	Wall element- Wandelement- Panneau du mur- Elemento di muro- Elemento pared 	Veronica 2_6.7 5 Veronica 4_6.7 3	55x1196	2091
13	Door element- Türelement- Panneau du porte- Elemento di porta- Elemento puerta 	1	55x1196	2091
14	Window element- Fensterelement- Panneau de la fenêtre- Elemento di finestra- Elemento ventana 	Veronica 2_6.7 2 Veronica 4_6.7 4	55x1196	2091
15	Roof cap- Dachkappe- Finition métallique- Finitura di tetto- Caballete de tejado QK08-2 	1		
16	Wind brace- Windbrett- Madrier contre le vent- Tavola vento- Tabla contra el viento 	Veronica 2_6.7 5 Veronica 4_6.7 9	19x70	1075

Pos	SPECIFICATION - STÜCKLISTE - NOMENCLATURE - ELEMENTI "PAP28-2929"/"PA28-2929-1"	Pcs	Profile (mm)	Length (mm)
17	Fixing kit- Befestigungsset- Moyens de fixation- Materiale di fissaggio- Kit de fijación	1		
QULS130x 40	Cylinder- Zylinderschloss- Serrure a mortaiser- Serratura a cilindro- Bombin- 30.40	1		
QLIU KAPal	Door fittings- Türbeschlag- Ferrure- Ferramenta porta- Manilla puerta	1		
QLIA	Window fittings- Fenstergriff- Poigne de la fenêtre- Maniglia finestra- Manilla (ventana)	Veronica 2_6.7 / Veronica 4_6.7 2/4		
QKRPP4 _5x50Zn	Screw- Schraube- Vis- Vite- Tornillo- 4.5x50mm		210	
QKRPP4 _5x70Zn	Screw- Schraube- Vis- Vite- Tornillo- 4.5x70mm		68	
QKRPP5x 90Zn	Screw- Schraube- Vis- Vite- Tornillo- 5x90mm		40	
QKRPP6x 120Zn	Screw- Schraube- Vis- Vite- Tornillo- 6x120mm		22	
QNA1_4x 40Me	Nail- Nagel- Clou- Chiodo- Clavo- 1.4x40mm		28	
QNA2_2 x50Zn	Nail- Nagel- Clou- Chiodo- Clavo- 2.5x50mm		300	
QAF240Zn	Window stop- Fensterfeststelle- Crémaillere- Fissativo finestra- Fijador de ventana- QFK240Zn	Veronica 2_6.7 / Veronica 4_6.7 	4/8	
QRV120	Keeper- Schllessblech- Tole- Lamiera- Aldaba de candado	Veronica 2_6.7 / Veronica 4_6.7 	5/9	
QKRPP2 _5x16kZ n	Screw- Schraube- Vis- Vite- Tornillo- 2.5x16mm	Veronica 2_6.7 / Veronica 4_6.7 	12/20	
QKRPP3x 20Zn	Screw- Schraube- Vis- Vite- Tornillo- 3x20mm	Veronica 2_6.7 / Veronica 4_6.7 	48/72	
QT15_5x 9PR-2	Seal- Gummidichtung- Joint d'isolation- Guarnizione- Burlete- QT15_5x9PR	Veronica 2_6.7 / Veronica 4_6.7 	1/1	8000
QT15_5x 9PR-2	Seal- Gummidichtung- Joint d'isolation- Guarnizione- Burlete- QT15_5x9PR	Veronica 2_6.7 / Veronica 4_6.7 	2/4	6000
QHA150Z n	Hook- Haken- Crochet- Ganzio- Pestillo QHA150Z n	 	2	Door+Wall

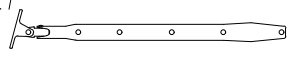
Pos	SPECIFIKATION - MÄÄRITYS "PAP28-2929"/"PA28-2929-1"	Pcs	Profile (mm)	Length (mm)
1	Grund-Perustus 	8	45x70	1185
2	Grund- Perustus 	2	45x70	1994
3	Grund- Perustus 	6	45x70	1360
4	Grund- Perustus 	3	45x45	600
5	Golvbräda- Lattialauta 			
5.1		13	19x89	1959
5.2		13	19x89	902
5.3		2	19x89	1959
5.4		2	19x89	902
5.5		2	19x89	1884
5.6		2	19x89	827
5.7		2	19x89	1795
5.8		2	19x89	738
5.9		2	19x89	2355
5.10		2	19x89	2177
5.11		2	19x89	1999
5.12		2	19x89	1821
5.13		2	19x89	1643
5.14		2	19x89	1465
5.15		2	19x89	1287
6	Passbit- Asennuslista 	3	6x12	1200
7	Golvllster- Lattialista 	7	19x40	1075
8	Spikläkt- Seinärima 	8+8	19x65	2056
9	Takstol- Katon jäykistystuki 	8	19x95	1075
10	Takfotsbräda- Räystään reuna 	8	19x95	1482

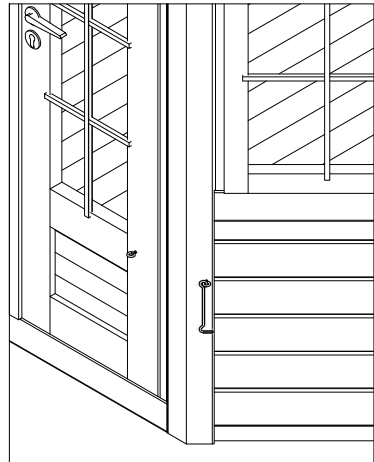

Pos	SPECIFIKATION - MÄÄRITYS "PAP28-2929"/"PA28-2929-1"	Pcs	Profile (mm)	Length (mm)
11	Takelement- Kattoelementti 	8	61x1441	2185
12	Väggelement- Seinäelementti 	Veronica 2_6.7 5 Veronica 4_6.7 3	55x1196	2091
13	Dörrelement- Ovielementti 	1	55x1196	2091
14	Fönsterelement- Ikkunaelementti 	Veronica 2_6.7 2 Veronica 4_6.7 4	55x1196	2091
15	Takåstäckning- Tuuletusputken hatt- QK08-2 	1		
16	Vindskiva- Tuulside Veronica 2_6.7 Veronica 4_6.7	5 9	19x70	1075

Pos	SPECIFIKATION - MÄÄRITYS "PAP28-2929"/"PA28-2929-1"	Pcs	Profile (mm)	Length (mm)
17	Infästningssats- Kiinnityssarja	1		
QULSI30x 40	Cylinder- Sylinteri		1	
QLIU KAPal	Dörrbeslag- Ovihelat		1	
QLIA	Fönsterbeslag- Ikkunahelat	Veronica 2_6.7 / Veronica 4_6.7 	2/4	
QKRPP4 _5x50Zn	Skruv- Ruuvi 4.5x50mm		210	
QKRPP4 _5x70Zn	Skruv- Ruuvi 4.5x70mm		68	
QKRPP5x 90Zn	Skruv- Ruuvi 5x90mm		40	
QKRPP6x 120Zn	Skruv- Ruuvi 6x120mm		22	
QNA1_4x 40Me	Spik- Naula 1.4x40mm		28	
QNA2_2 x50Zn	Spik- Naula 2.5x50mm		300	
QAF240Zn	Fönsterstopp- Ikkunan rajoitin	Veronica 2_6.7 / Veronica 4_6.7 	4/8	
QRV120	Hållare- Pidike	Veronica 2_6.7 / Veronica 4_6.7 	5/9	
QKRPP2 _5x16kZ n	Skruv- Ruuvi 2.5x16mm	Veronica 2_6.7 / Veronica 4_6.7 	12/20	
QKRPP3x 20Zn	Skruv- Ruuvi 3x20mm	Veronica 2_6.7 / Veronica 4_6.7 	48/72	
QT15_5x 9PR-2	Tiiviste- Tätning- QT15_5x9PR	Veronica 2_6.7 / Veronica 4_6.7 	1/1	8000
QT15_5x 9PR-2	Tiiviste- Tätning- QT15_5x9PR	Veronica 2_6.7 / Veronica 4_6.7 	2/4	6000
QHA150Z n	Krok- Koukku	 	2	Dörr+Vägg Ovi+Seinä

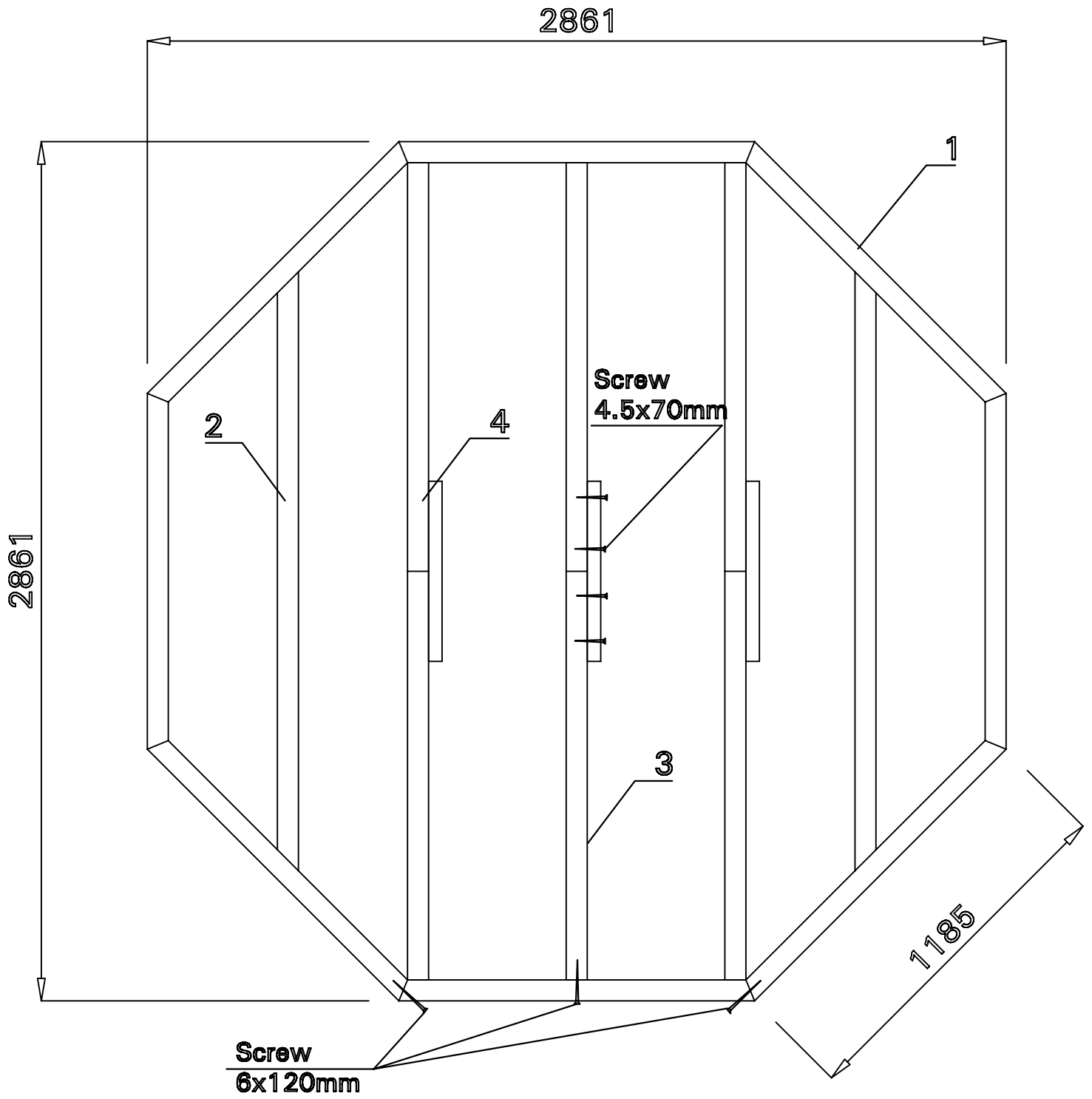

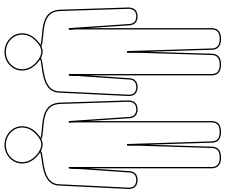

Ø4

Ø3

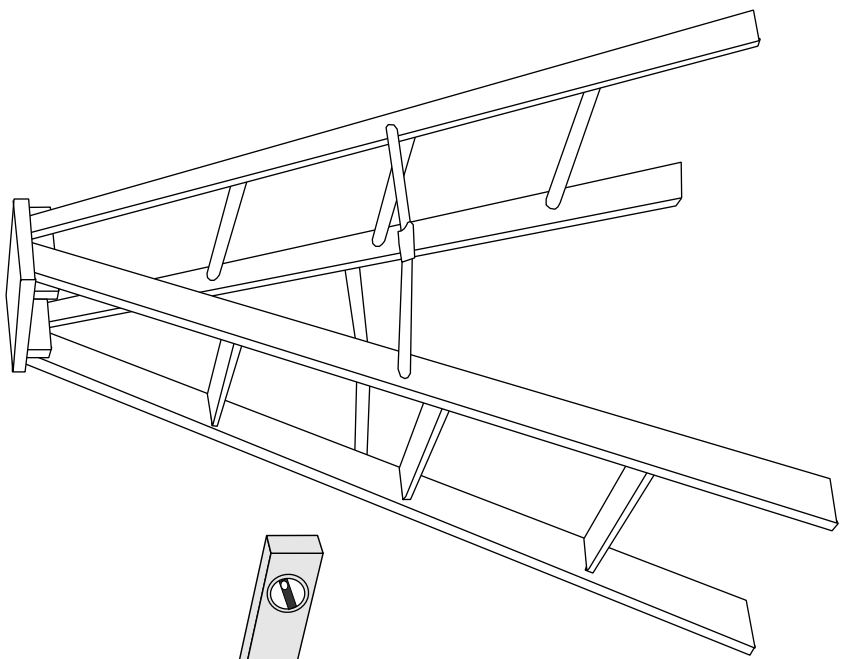
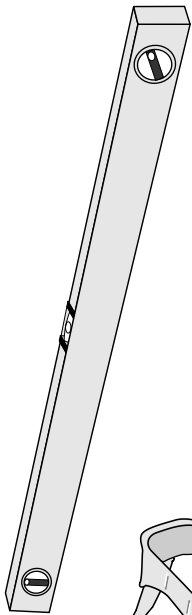
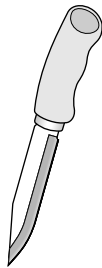
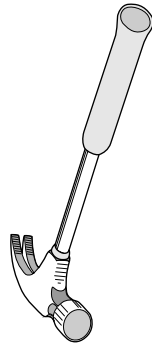
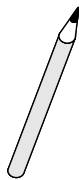
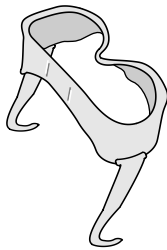
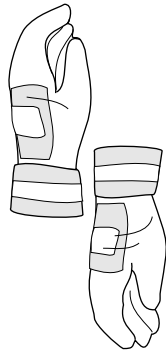
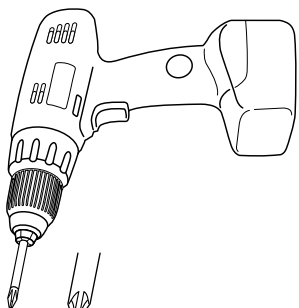
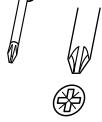

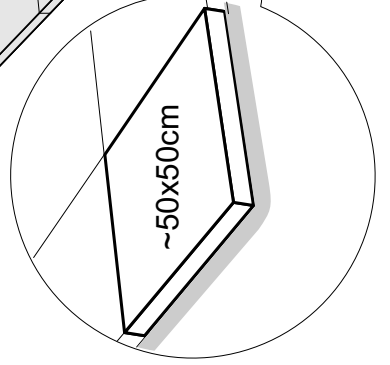
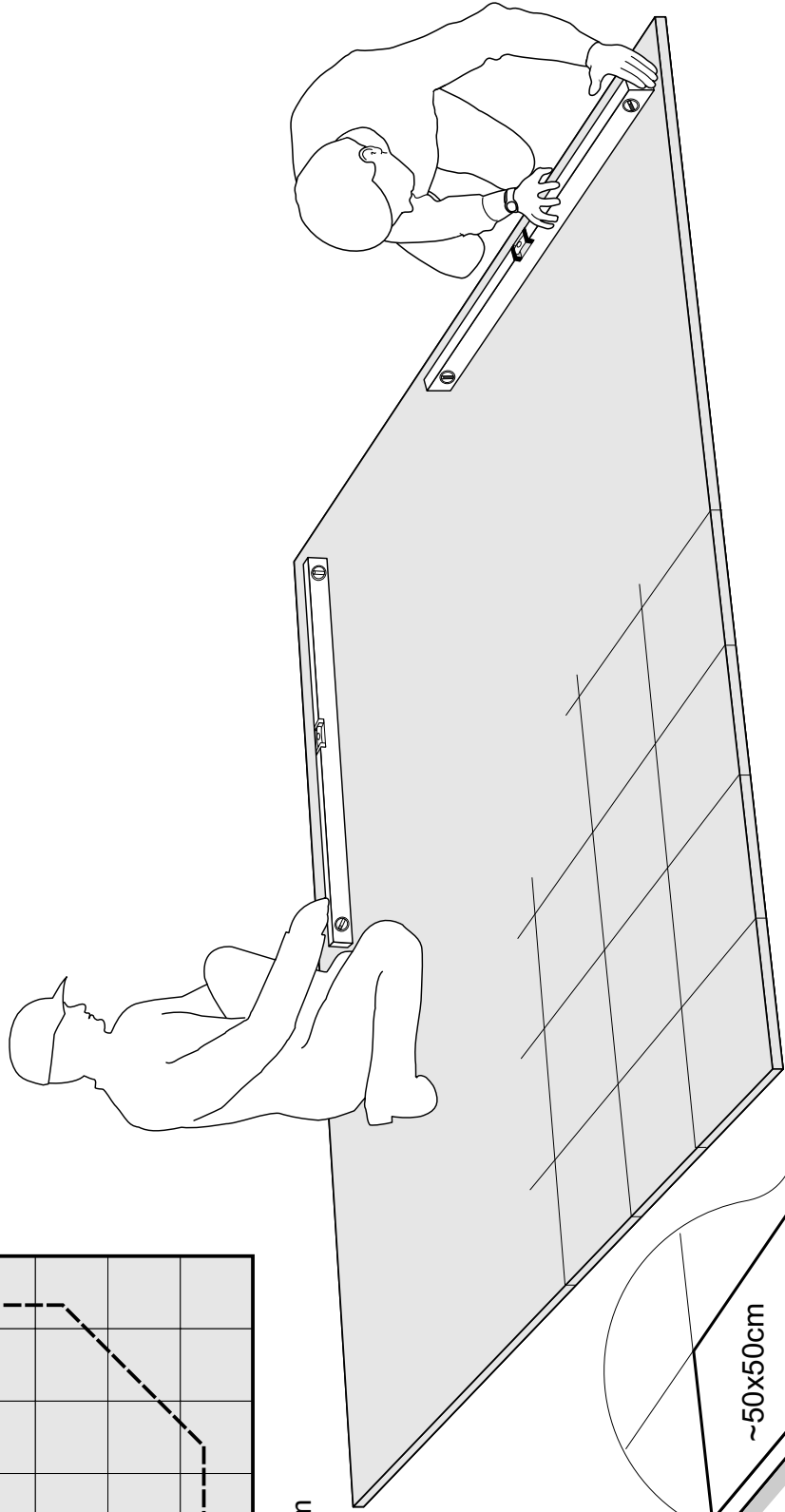
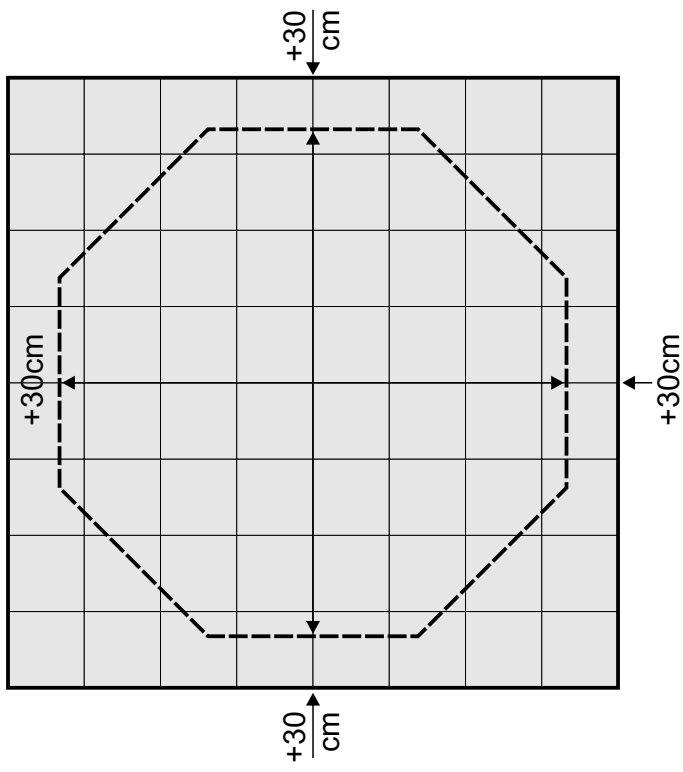
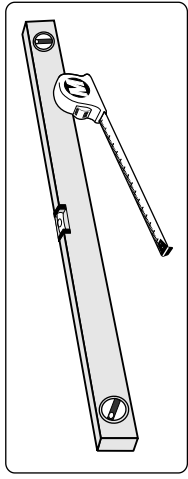

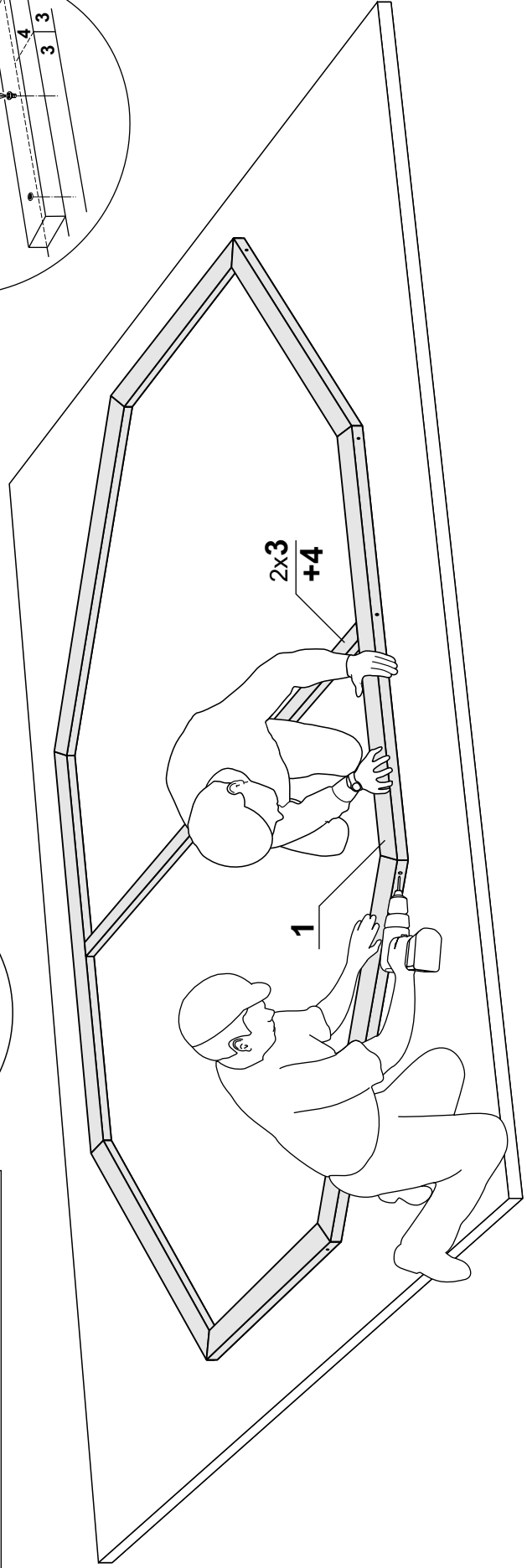
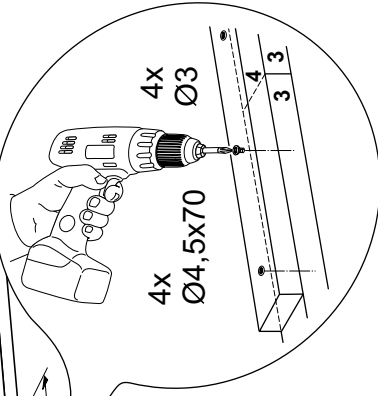
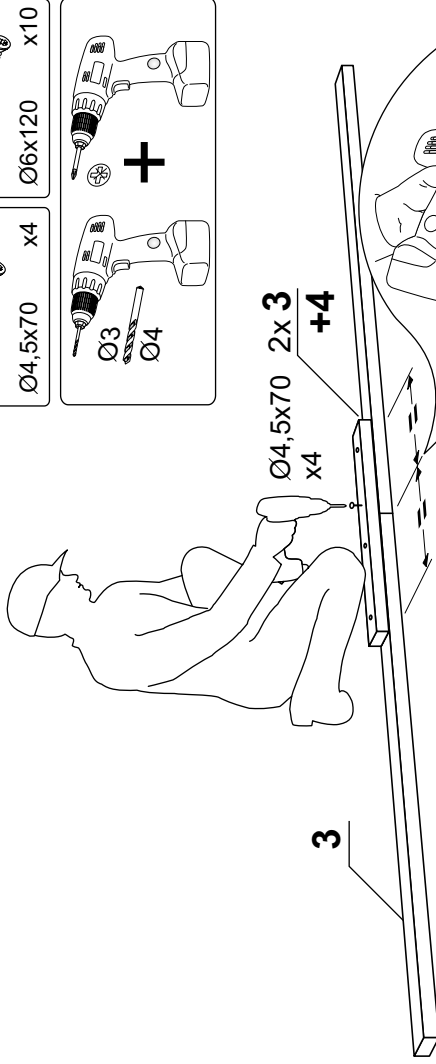
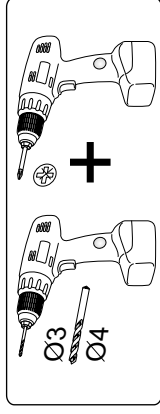
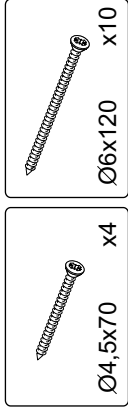
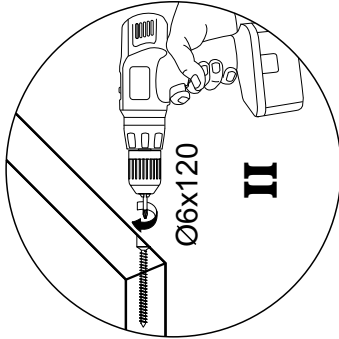
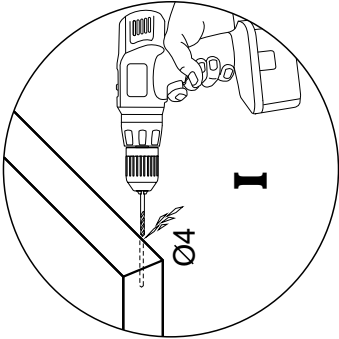
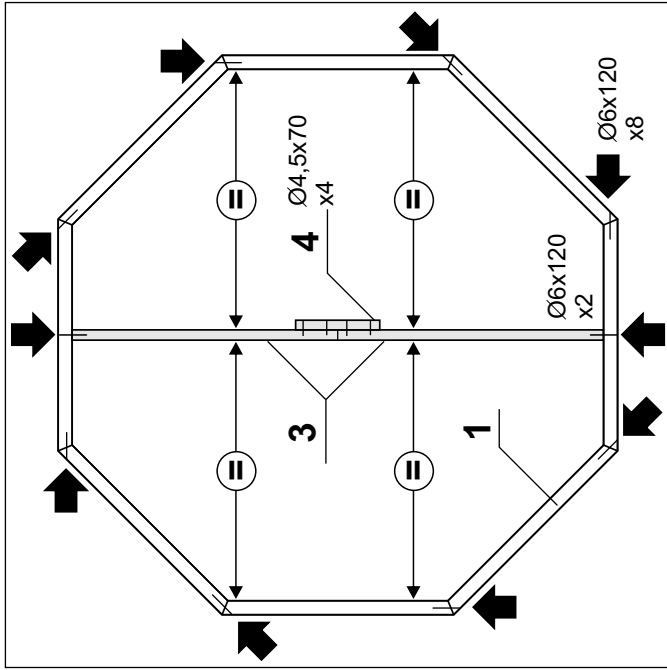

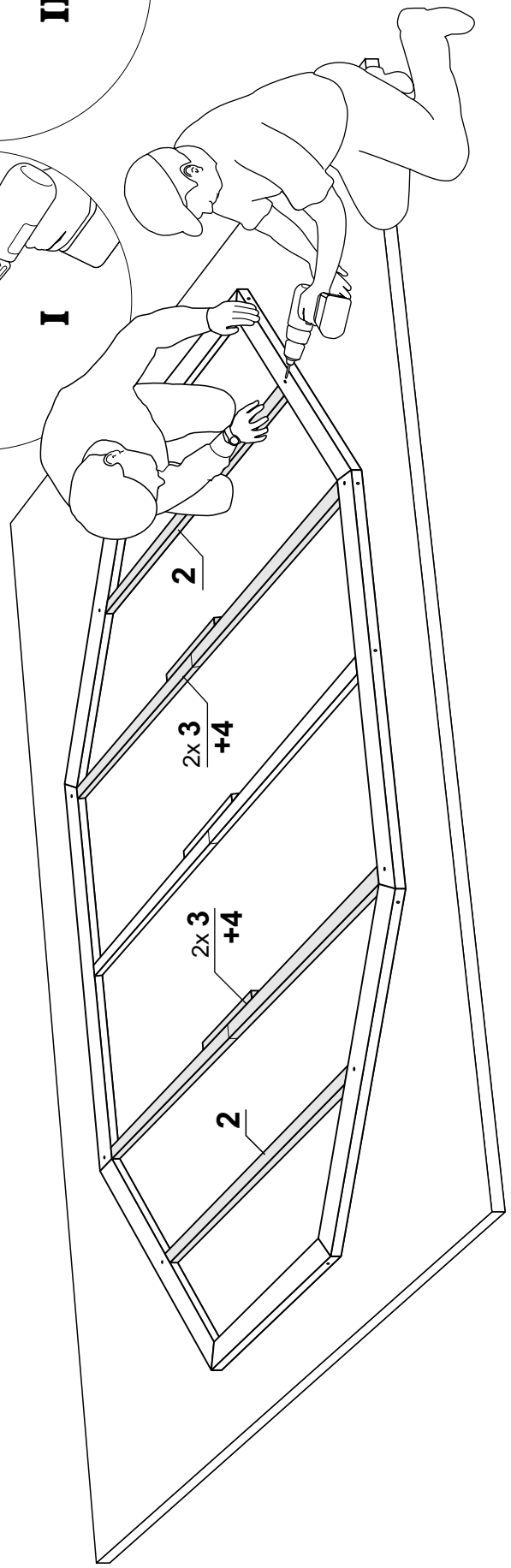
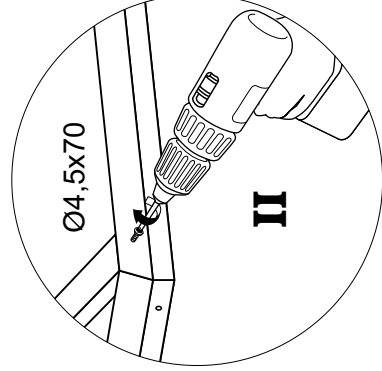
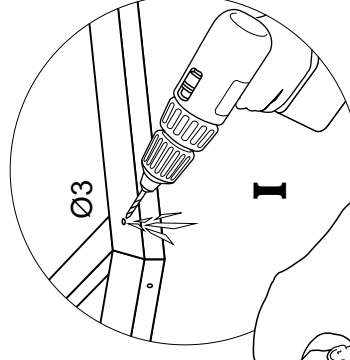
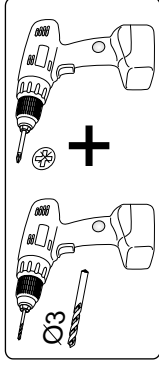
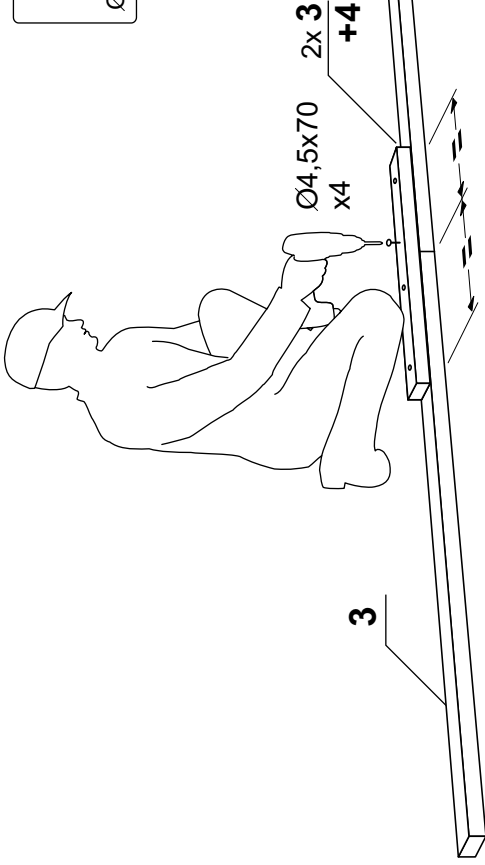
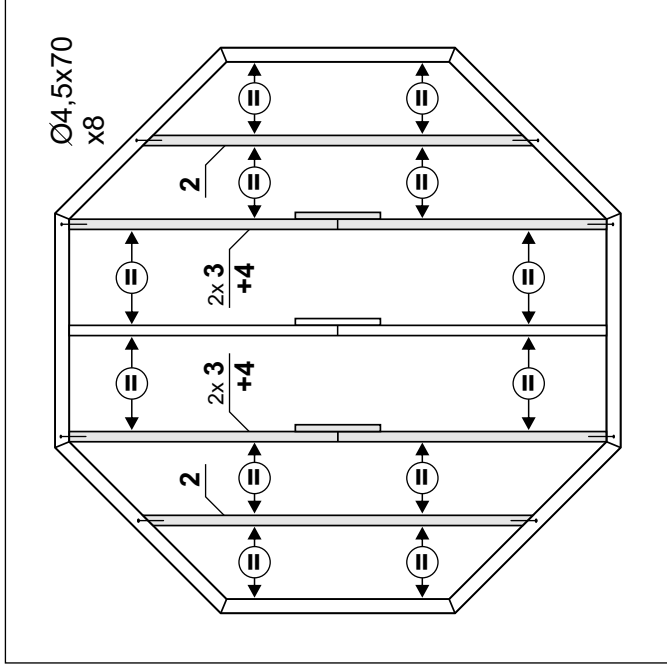

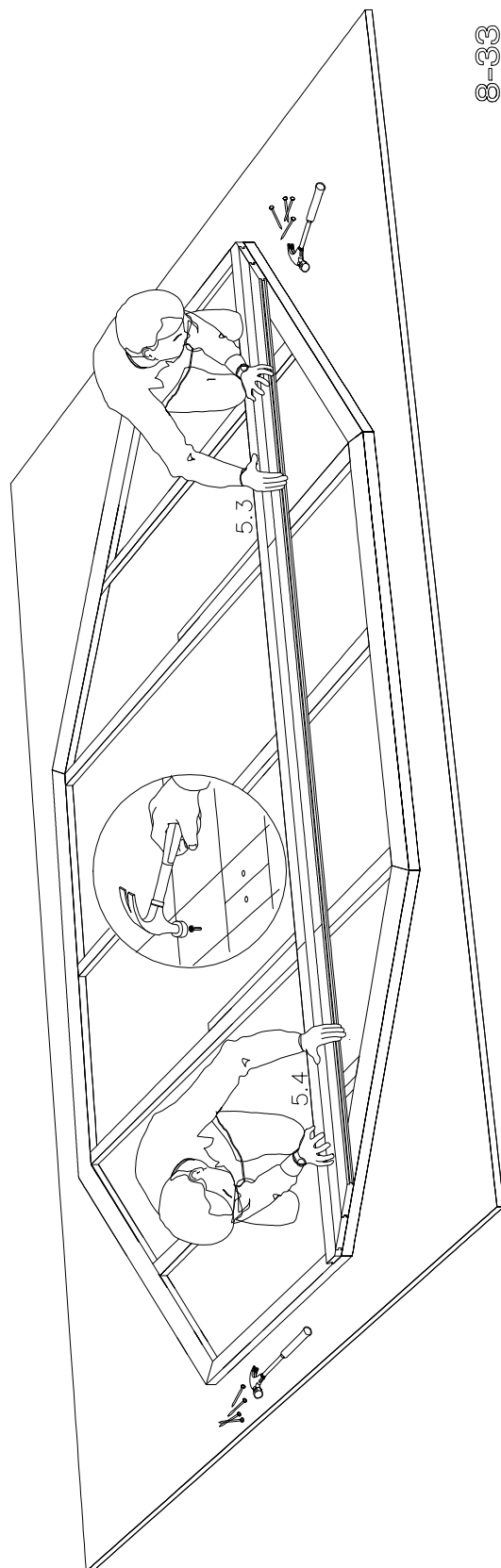
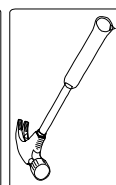
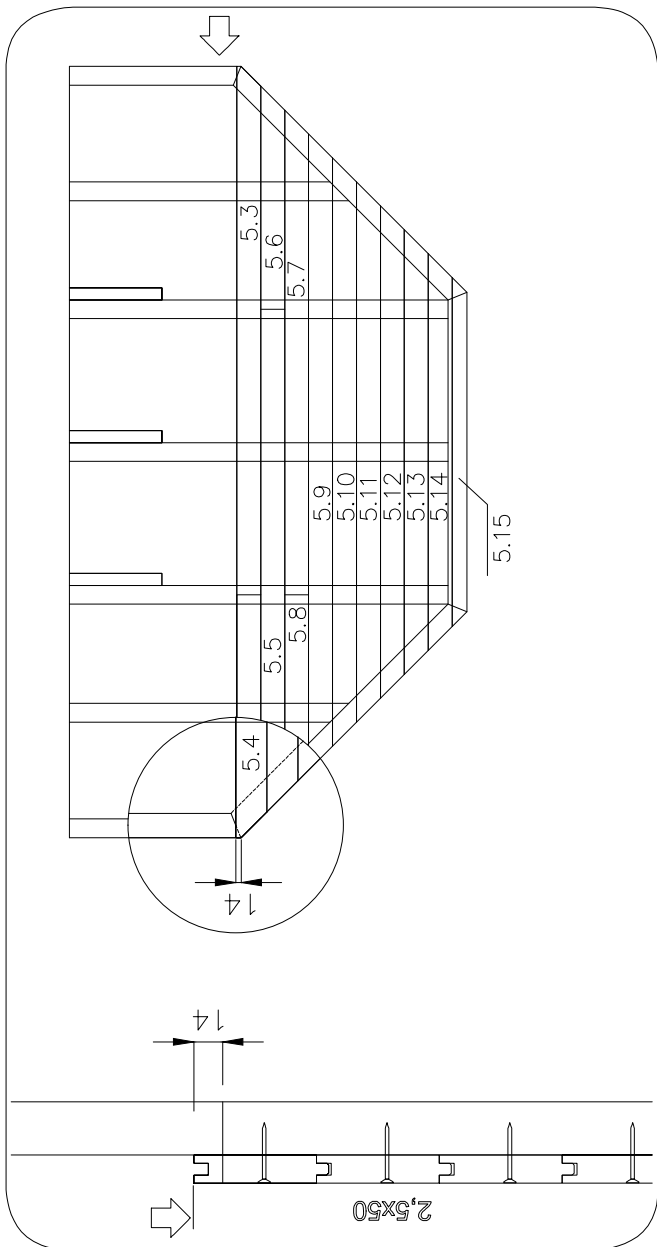
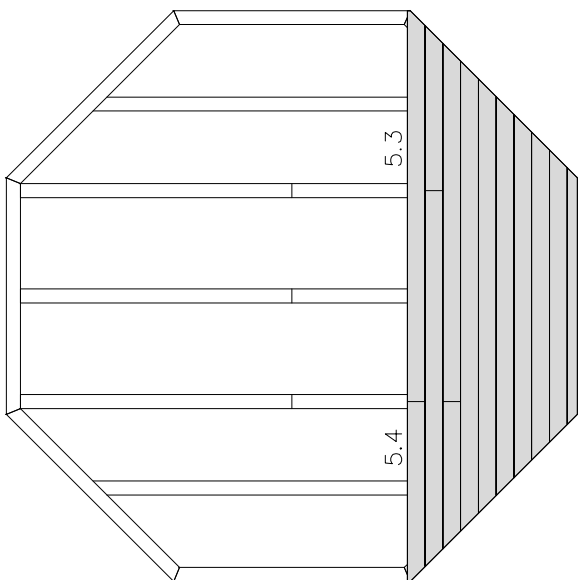



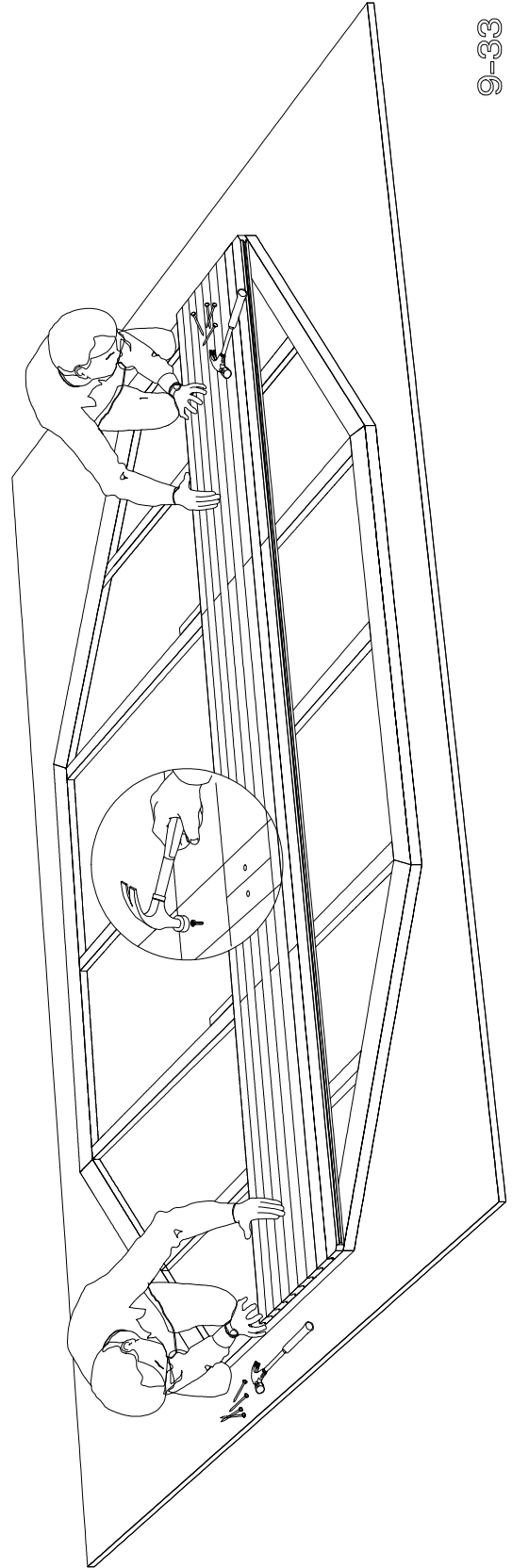
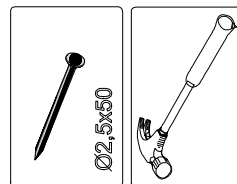
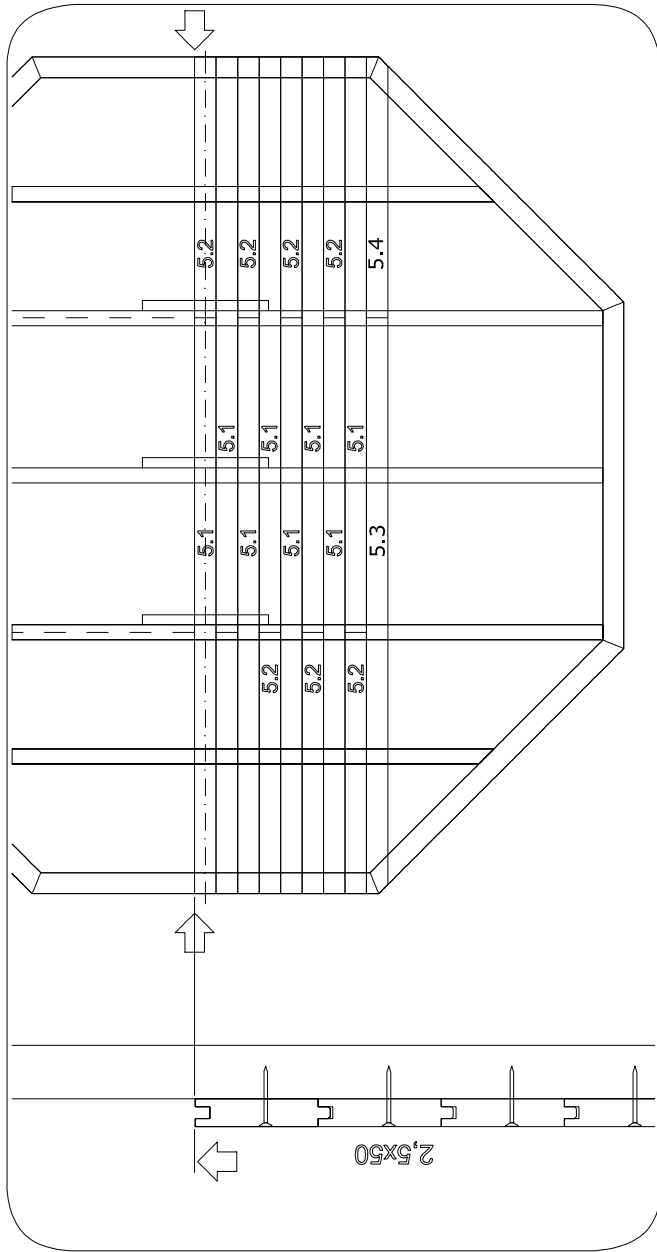
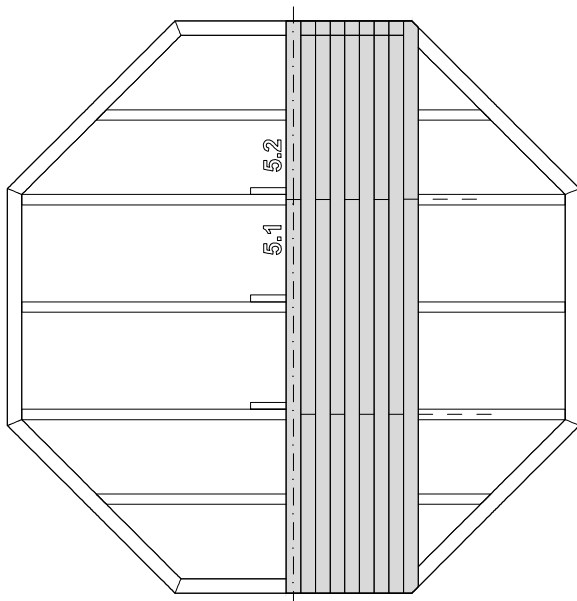

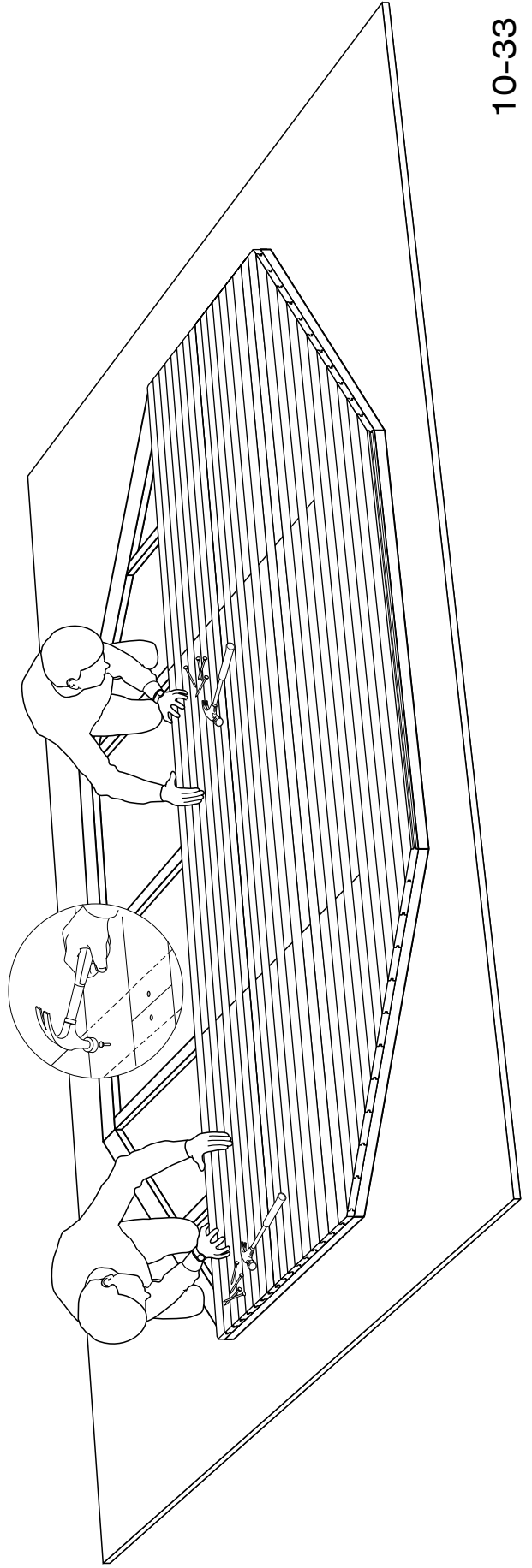
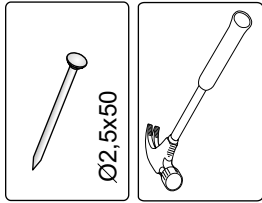
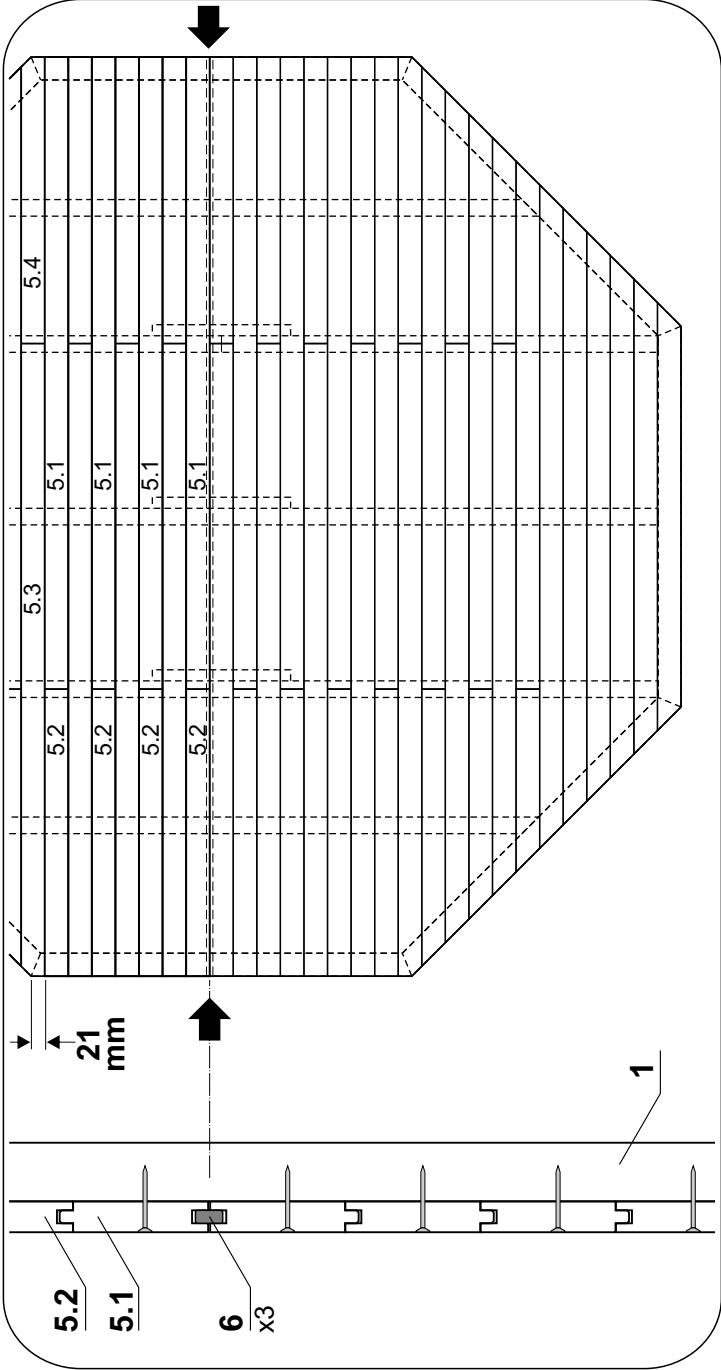
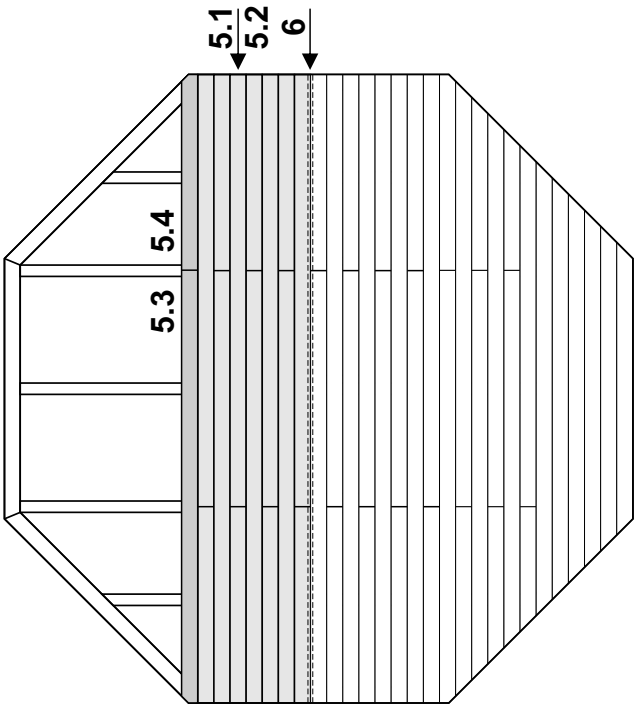

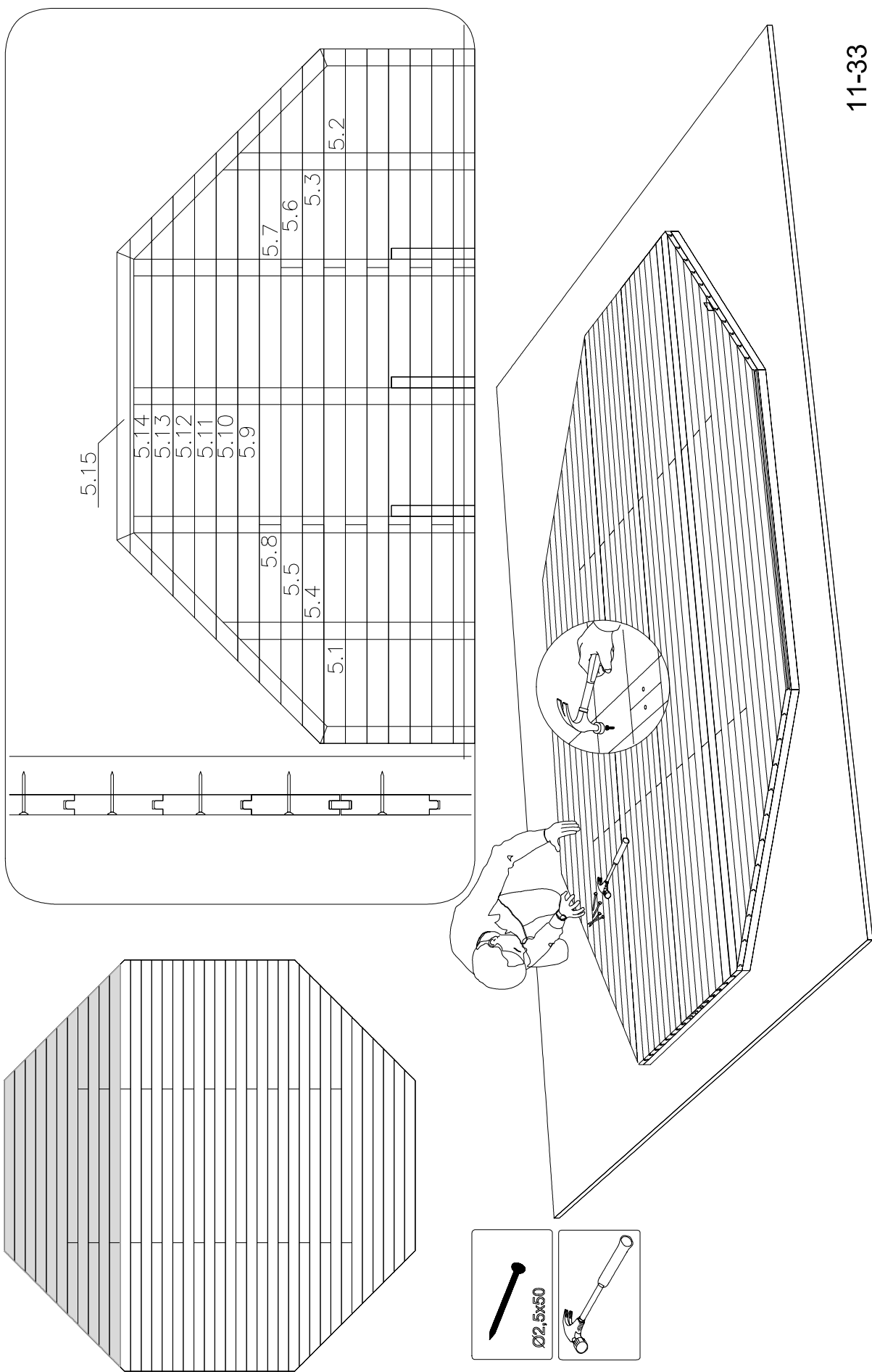

11-33

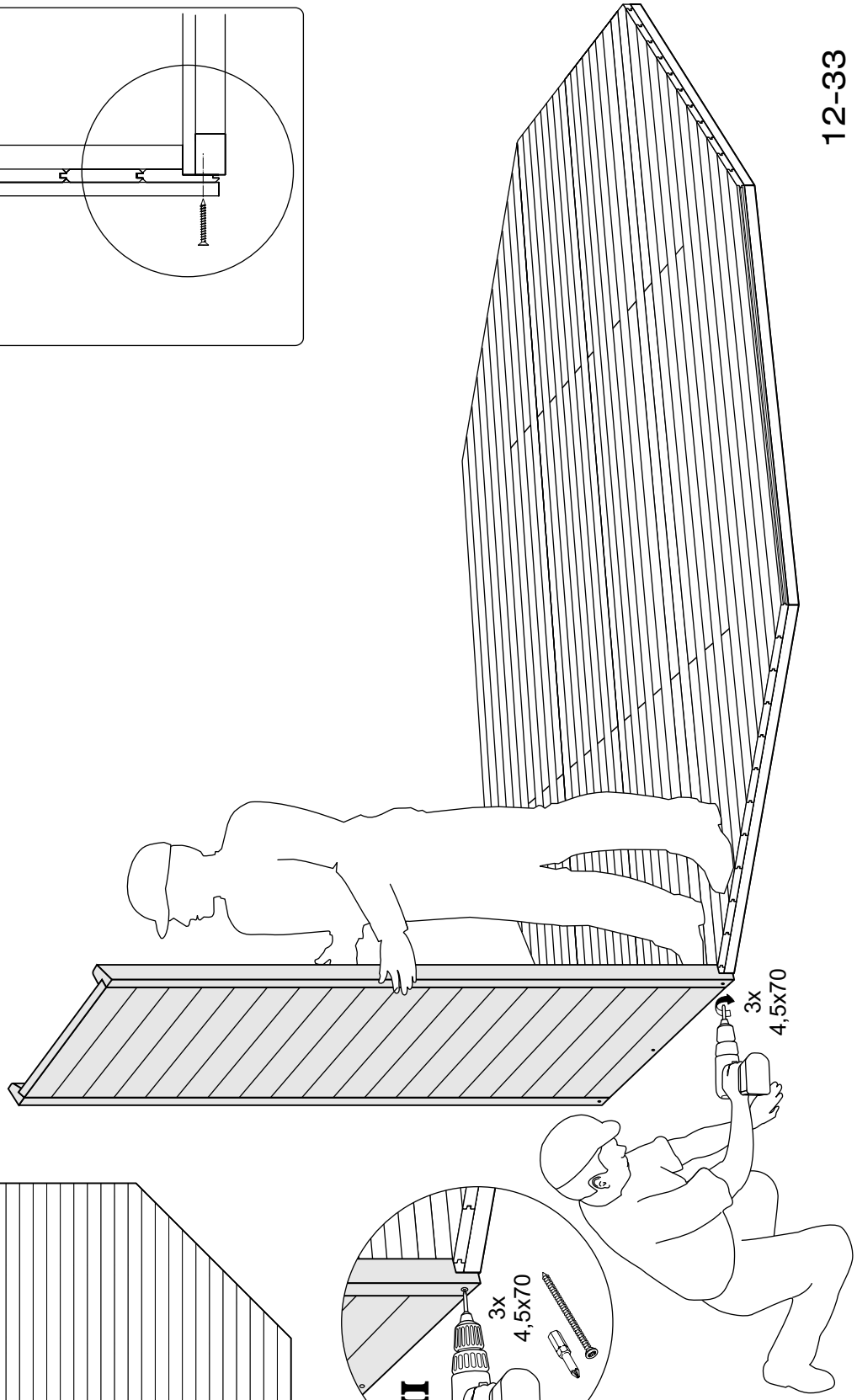
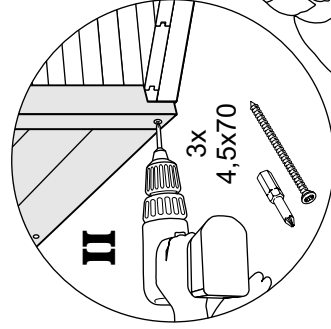
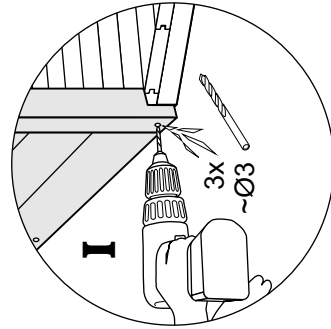
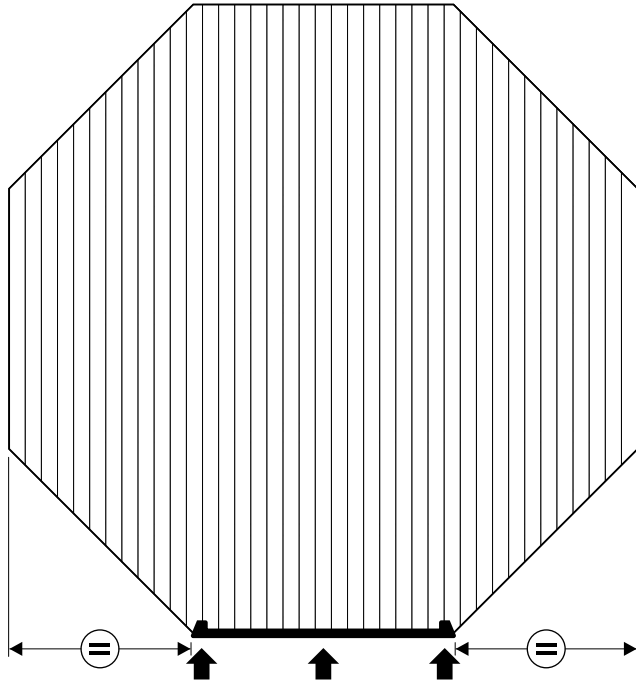
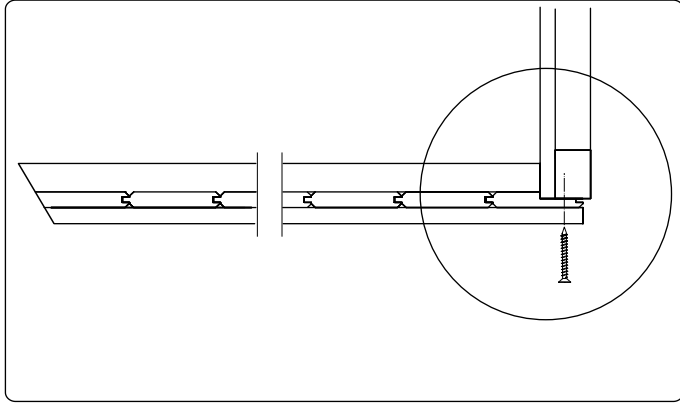
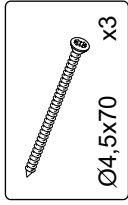
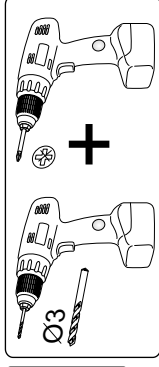

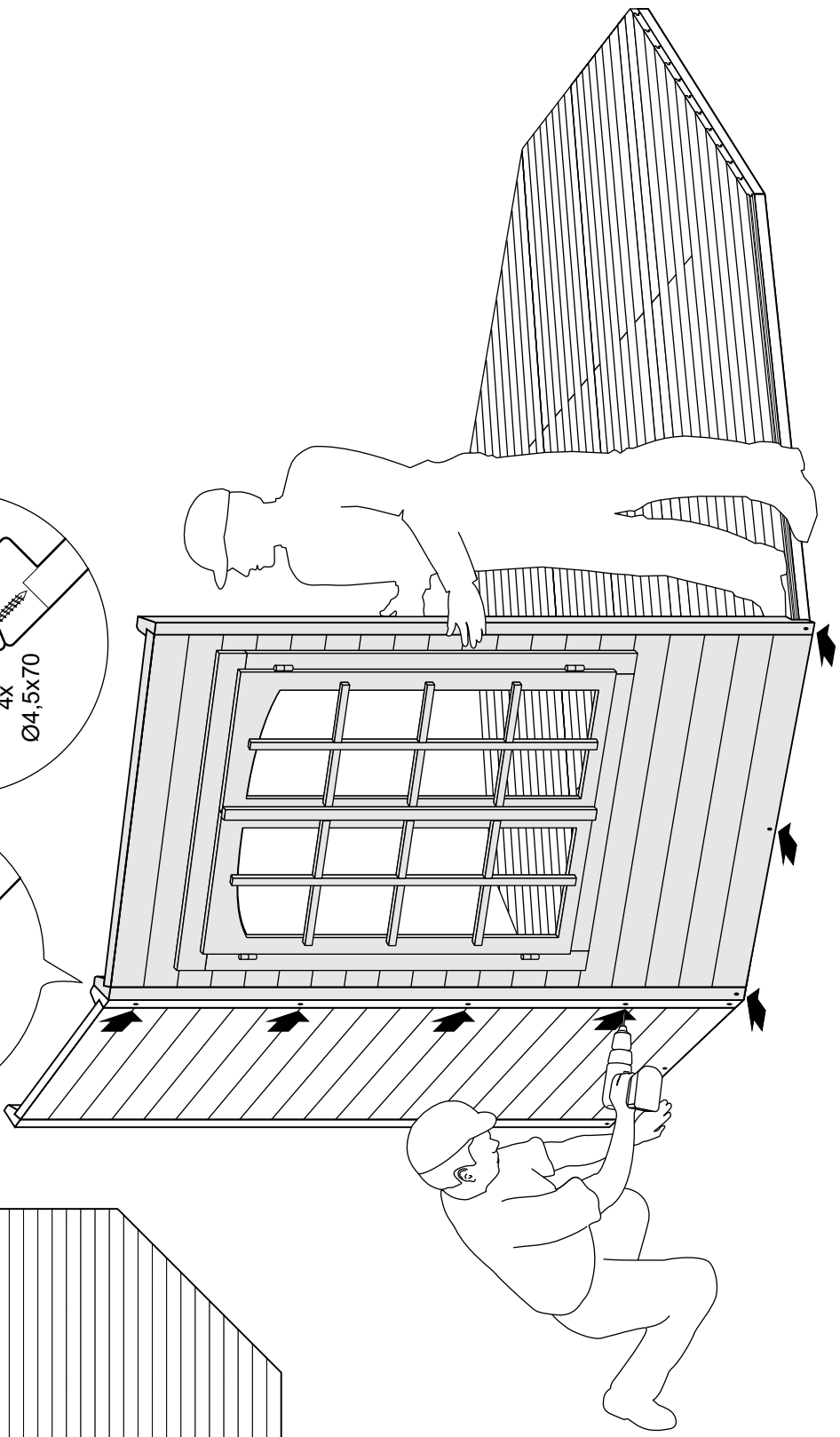
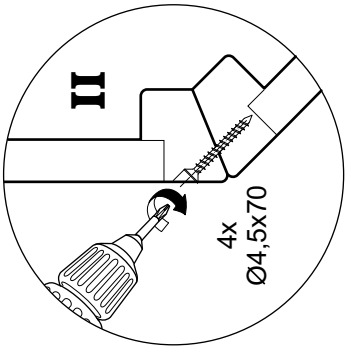
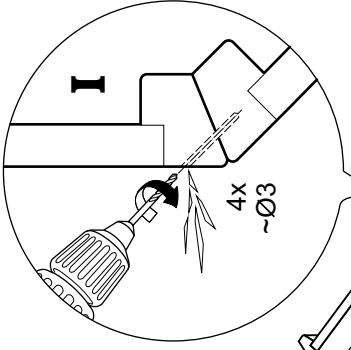
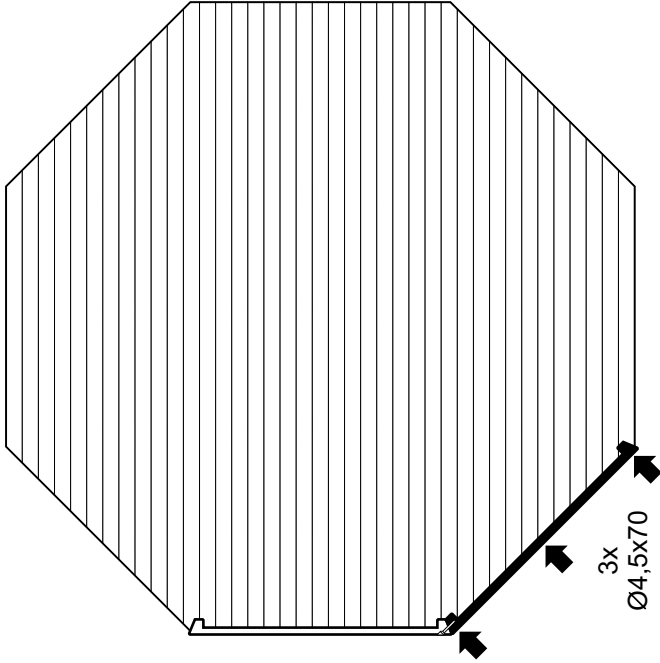
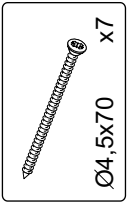
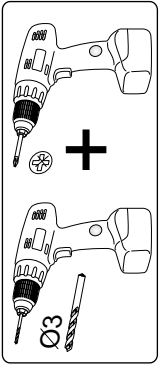

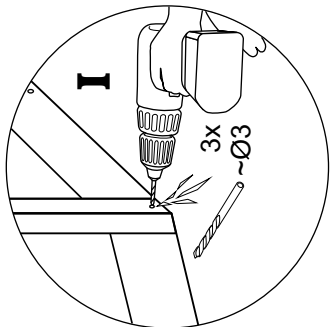
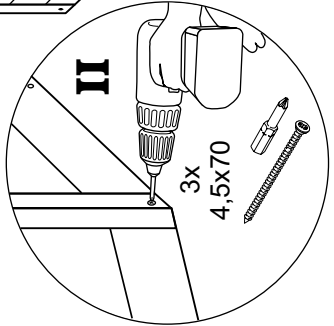
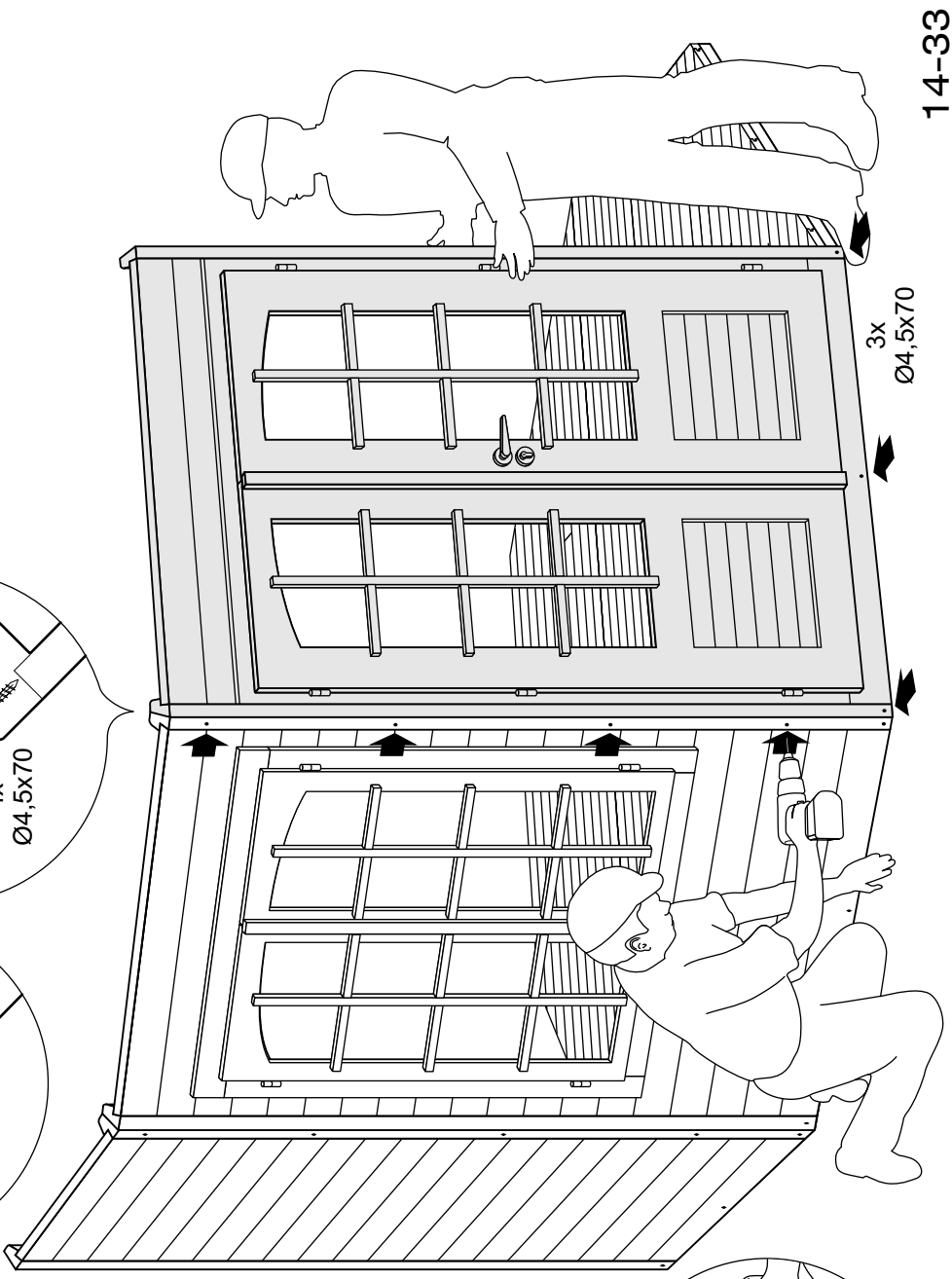
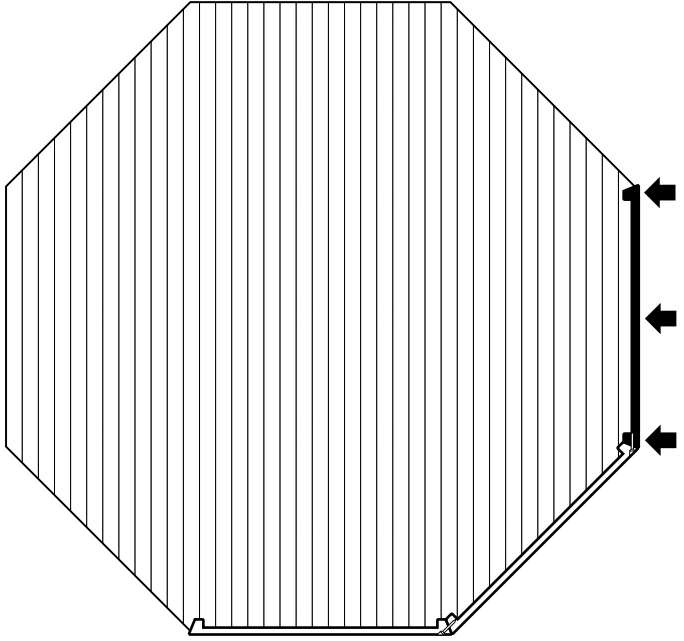
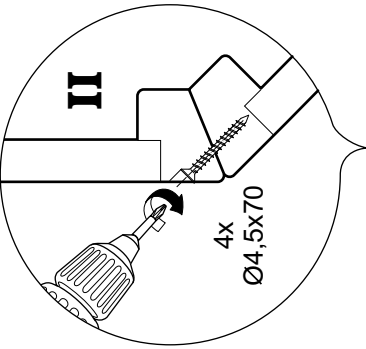
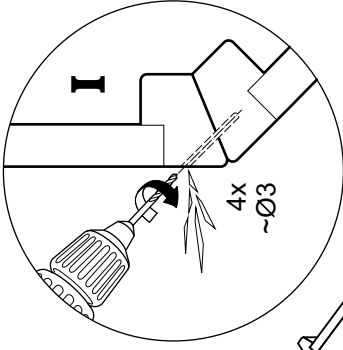
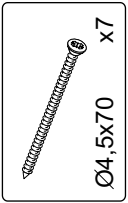
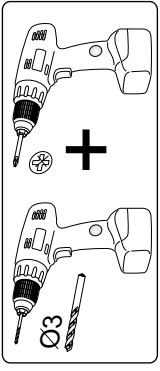

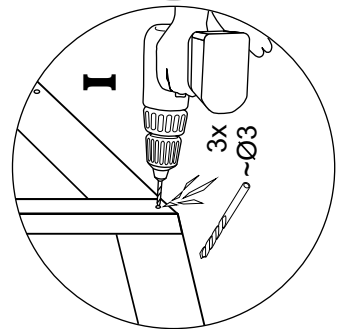
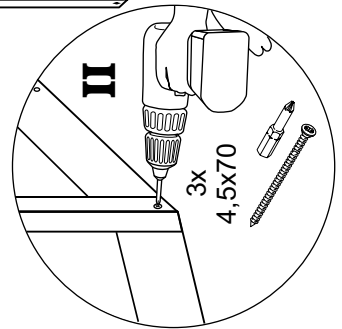
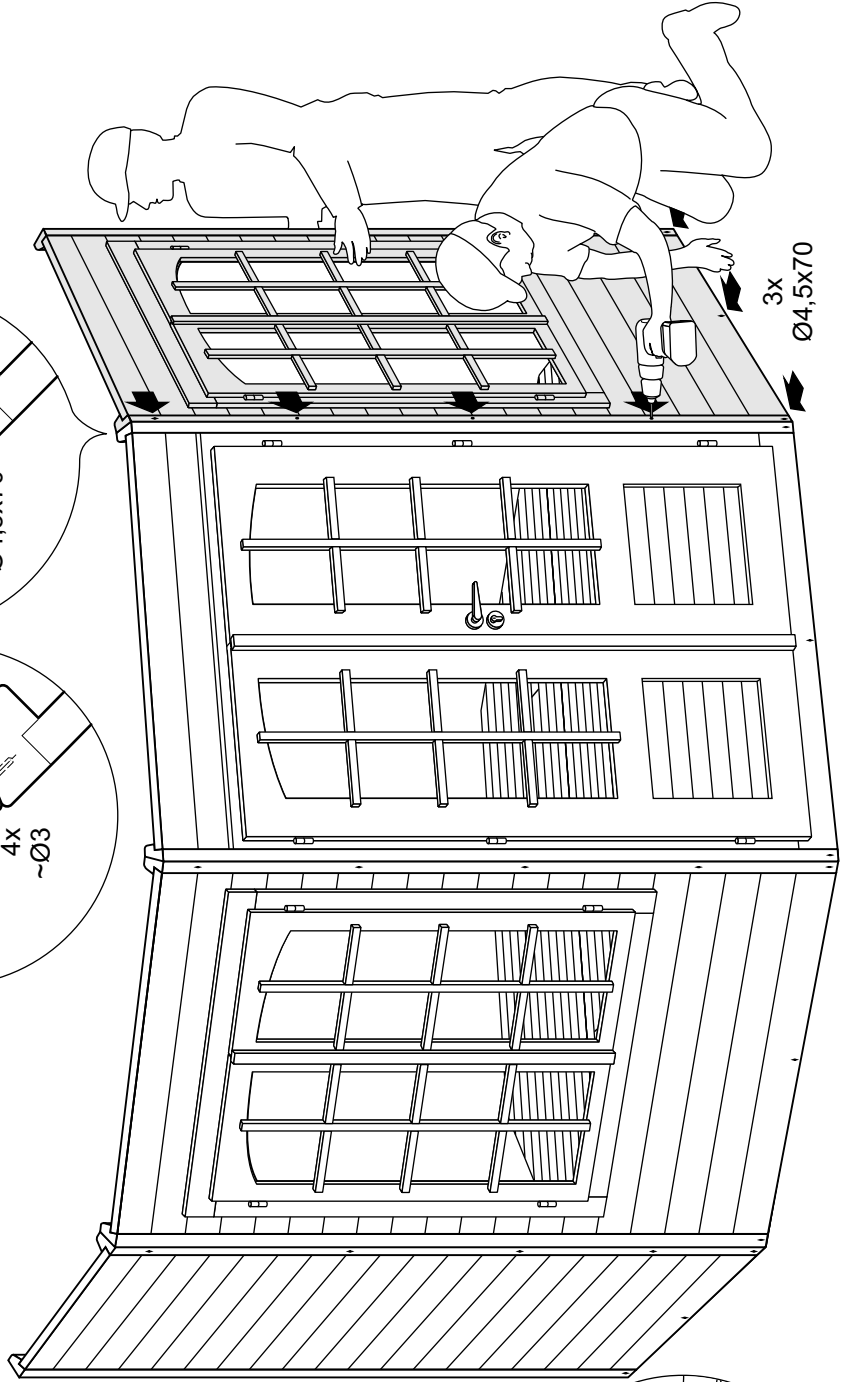
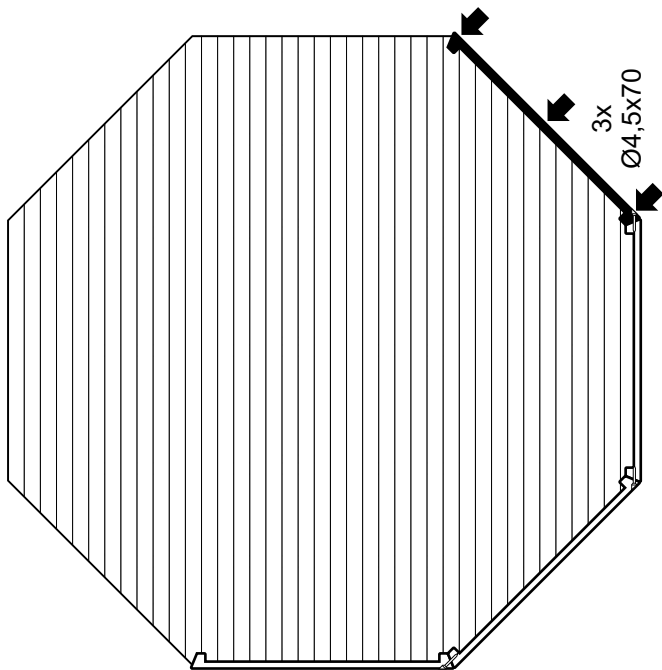
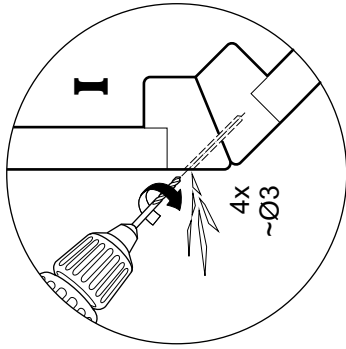
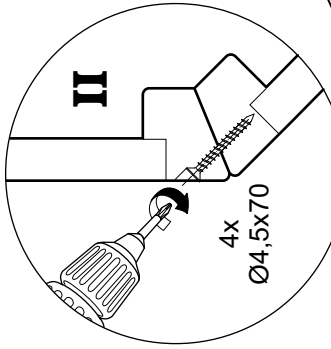
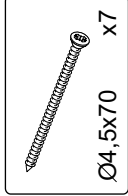
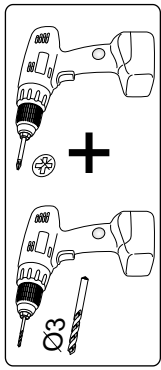

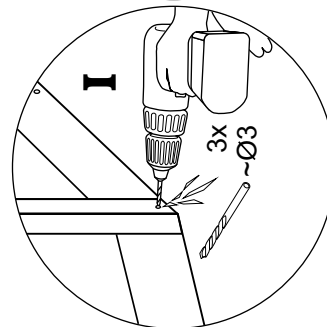
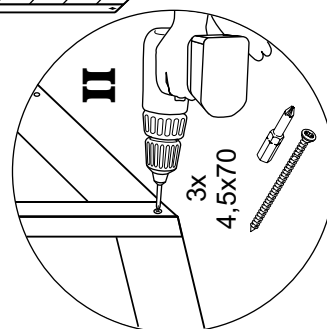
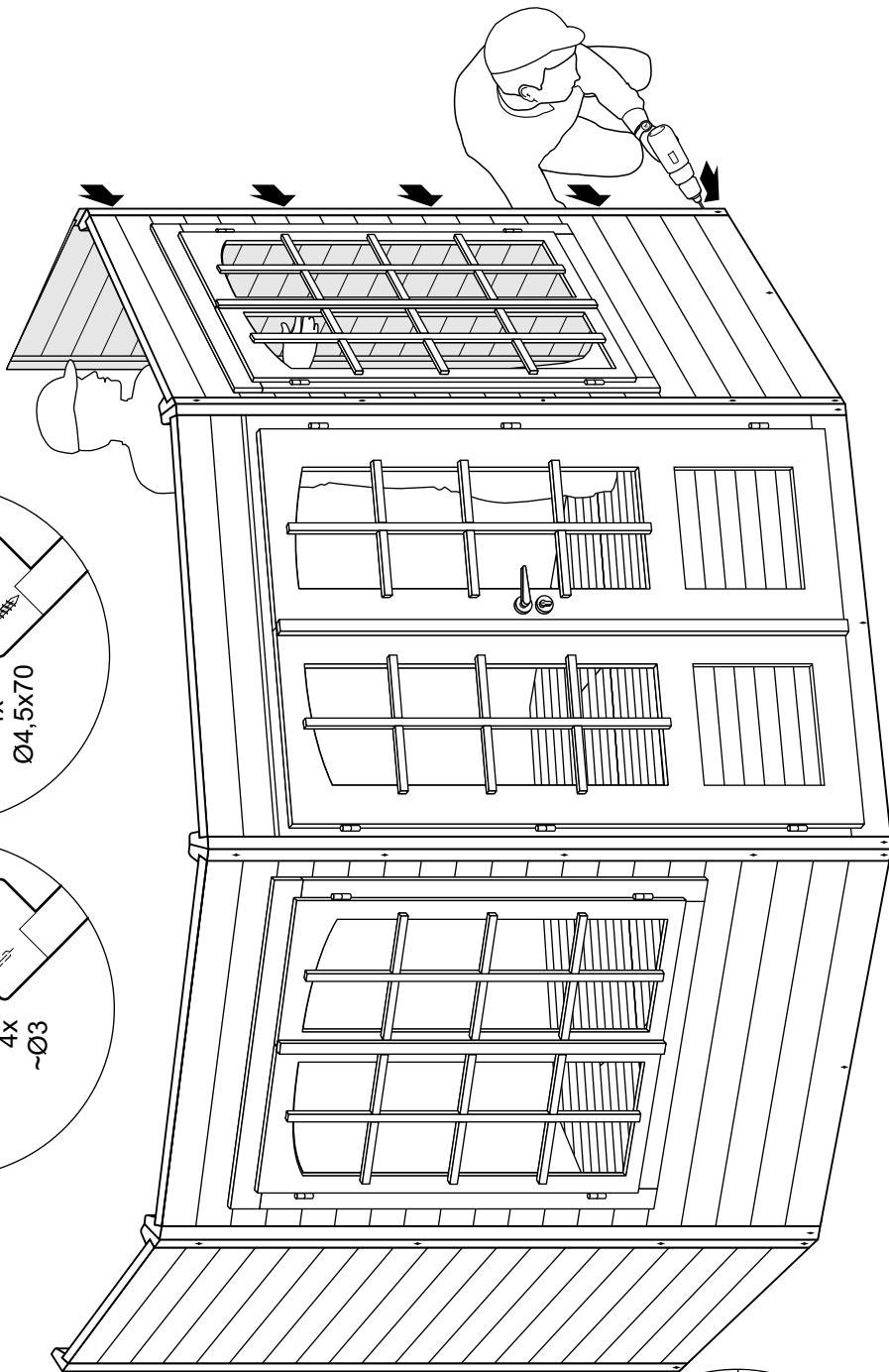
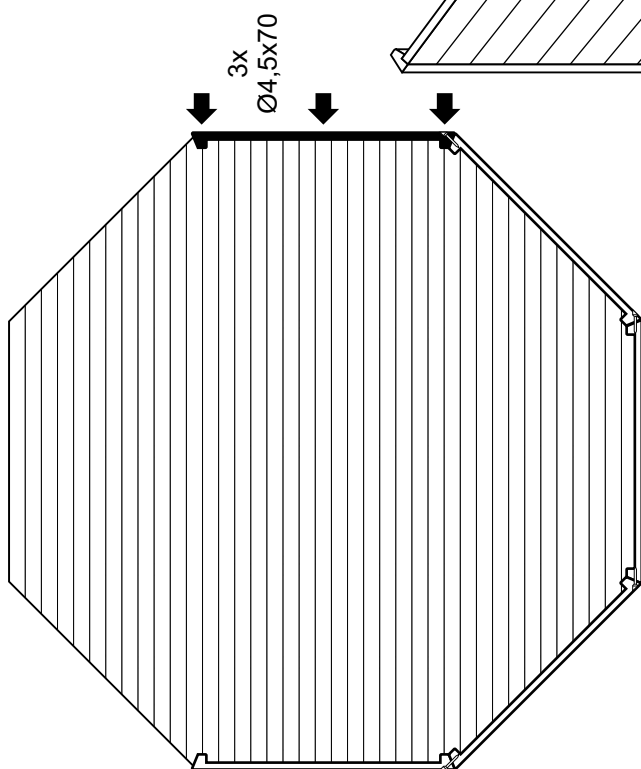
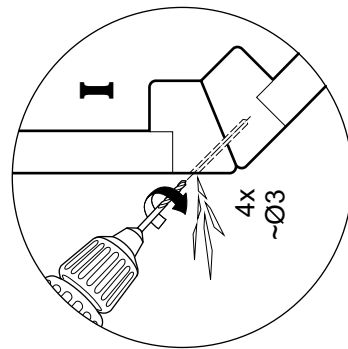
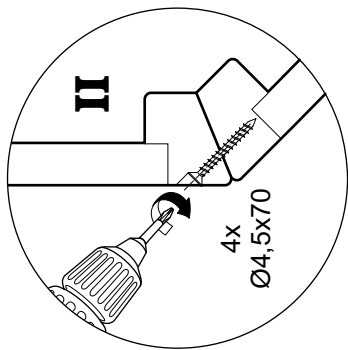
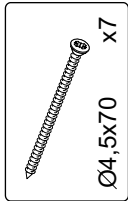
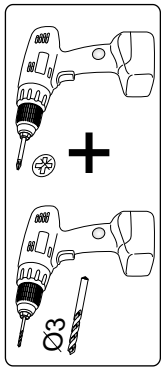



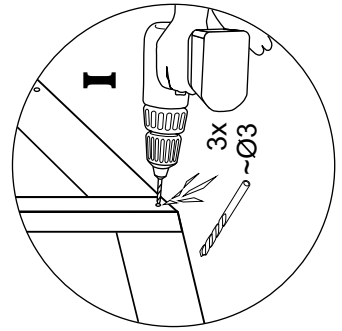
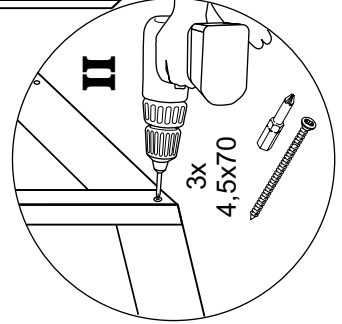
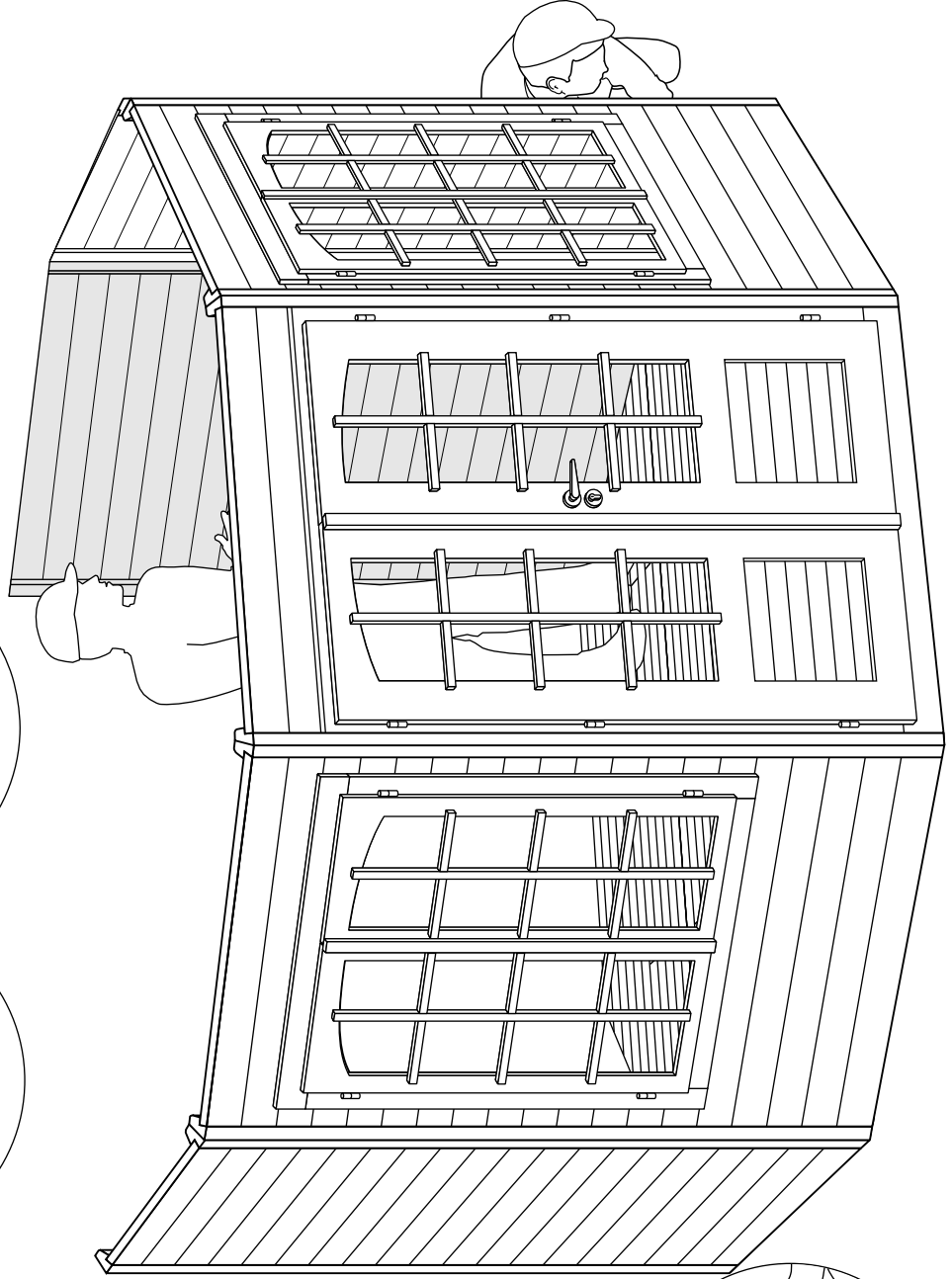
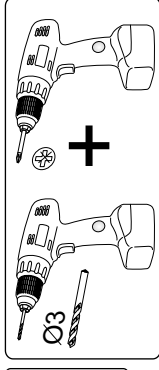
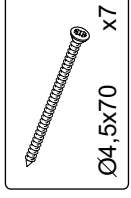
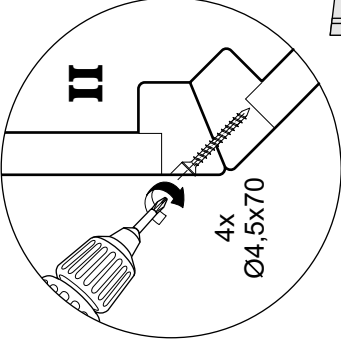
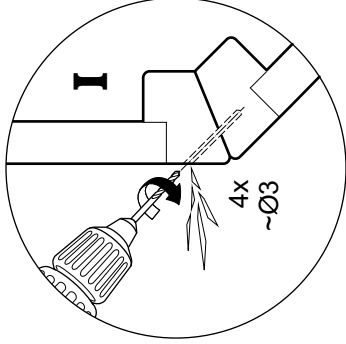
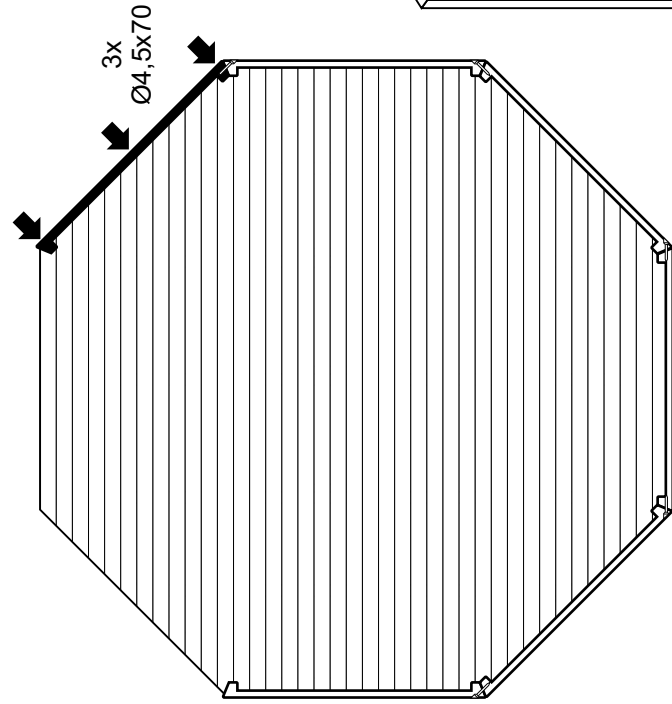

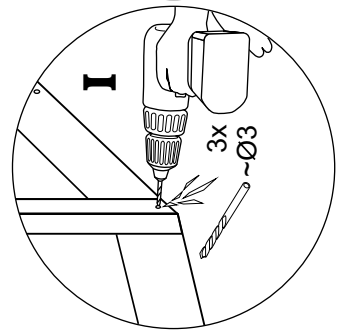
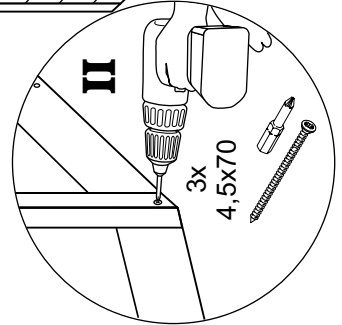
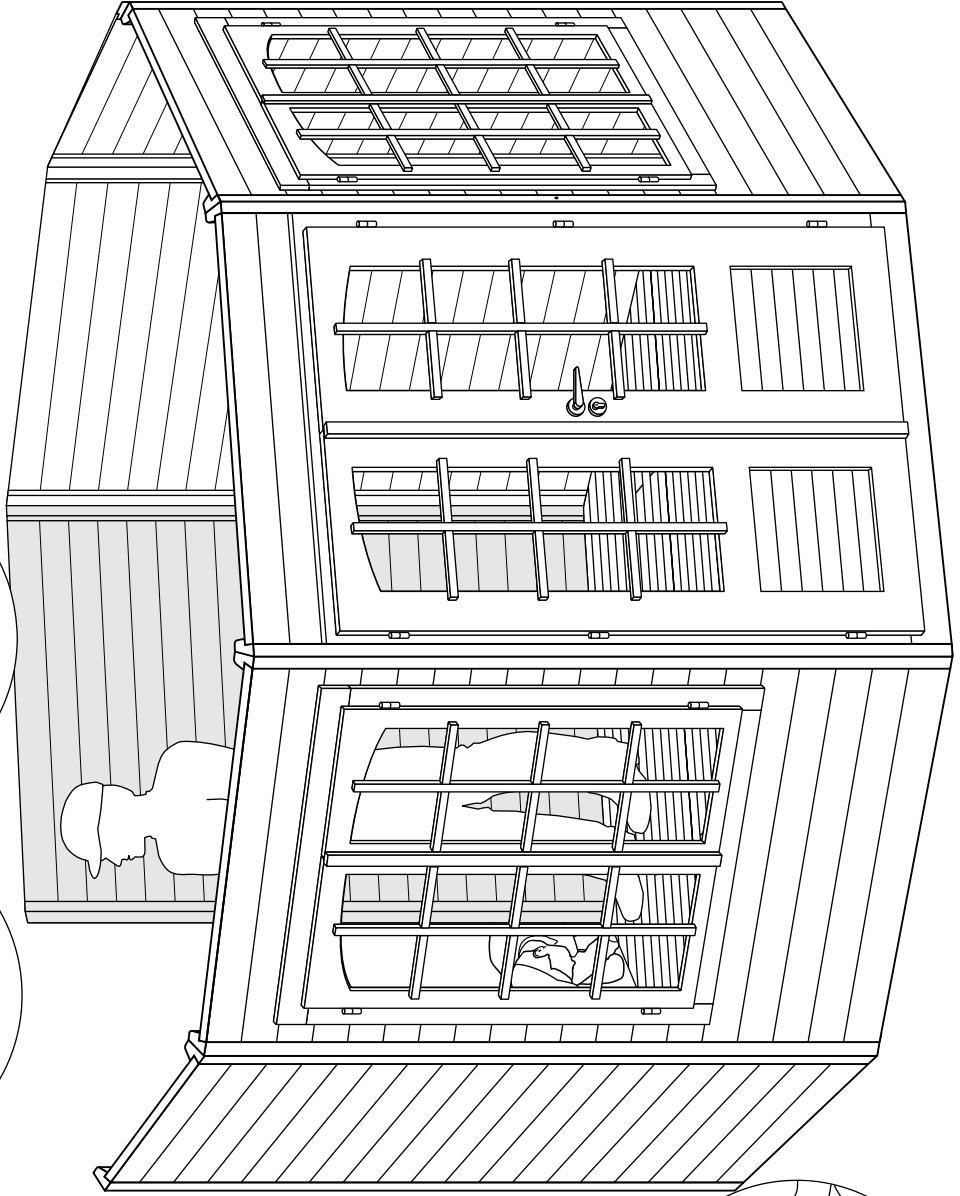
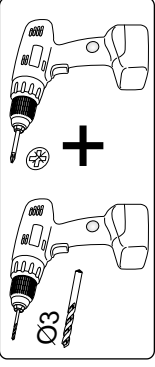
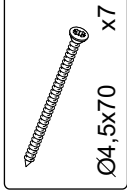
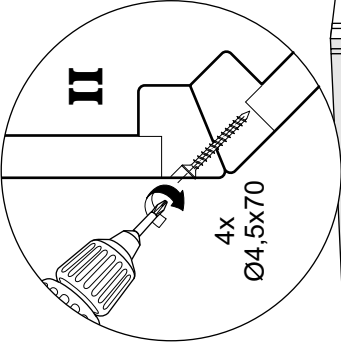
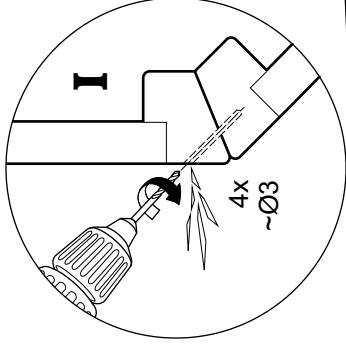
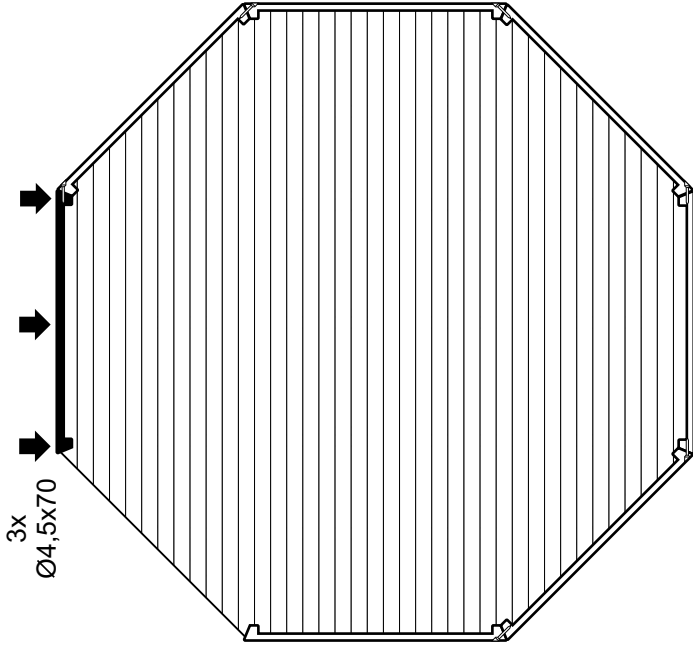

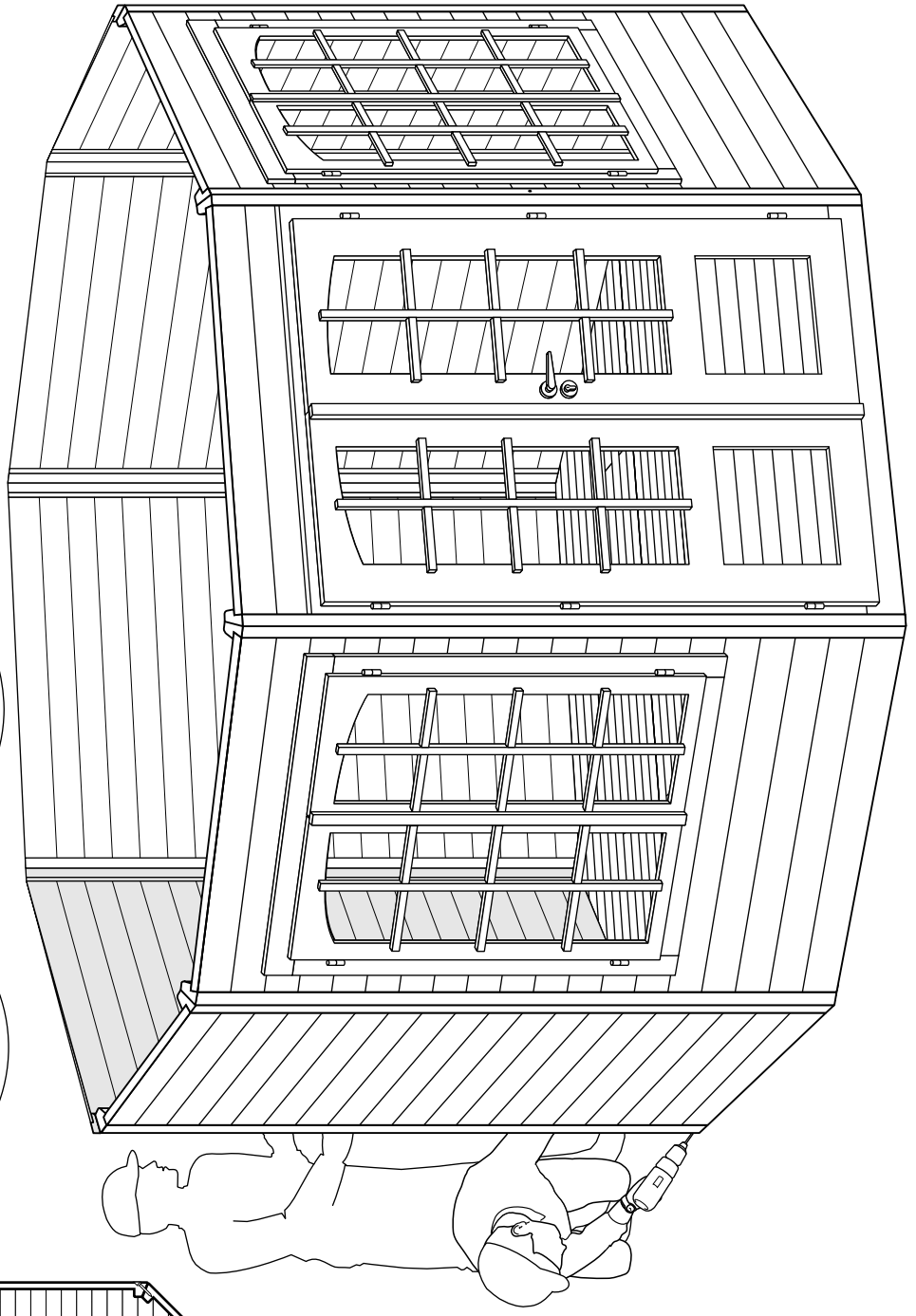
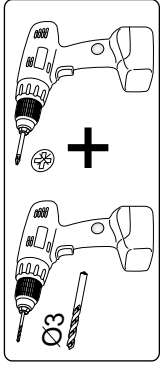
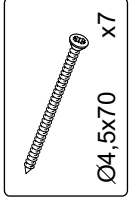
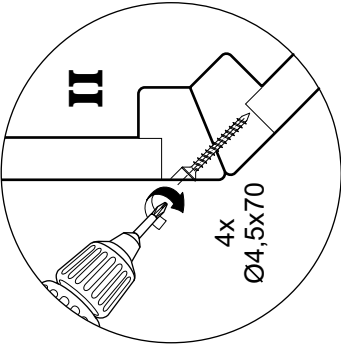
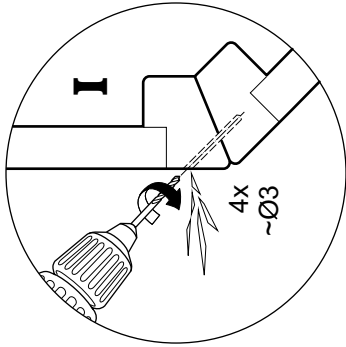
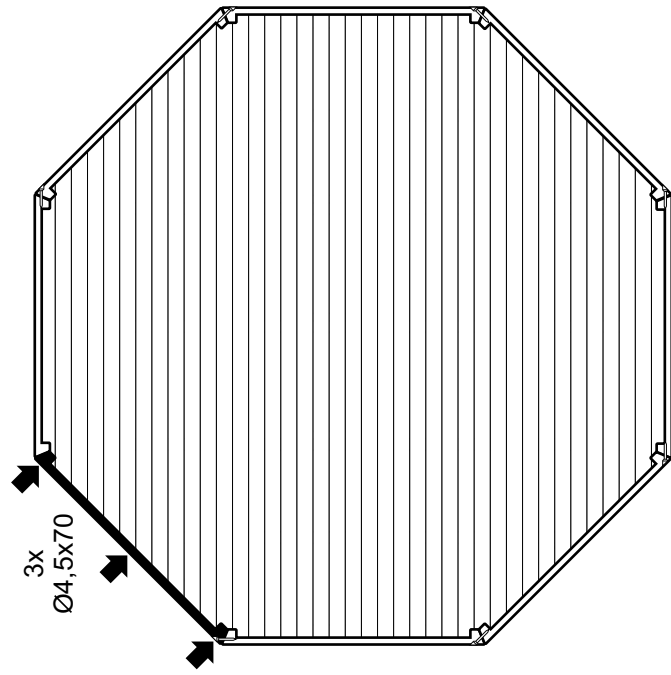

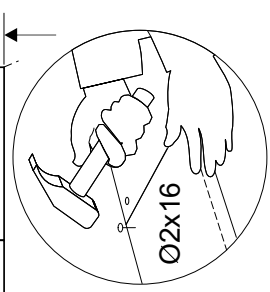
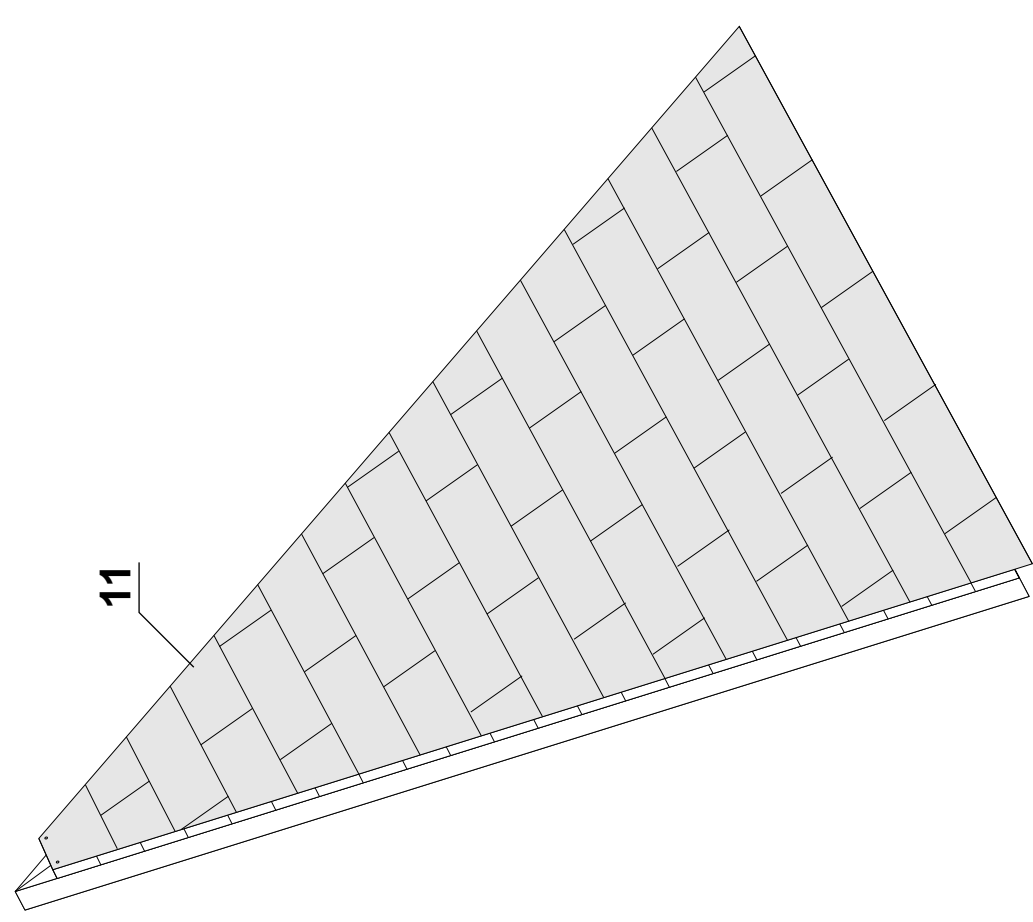
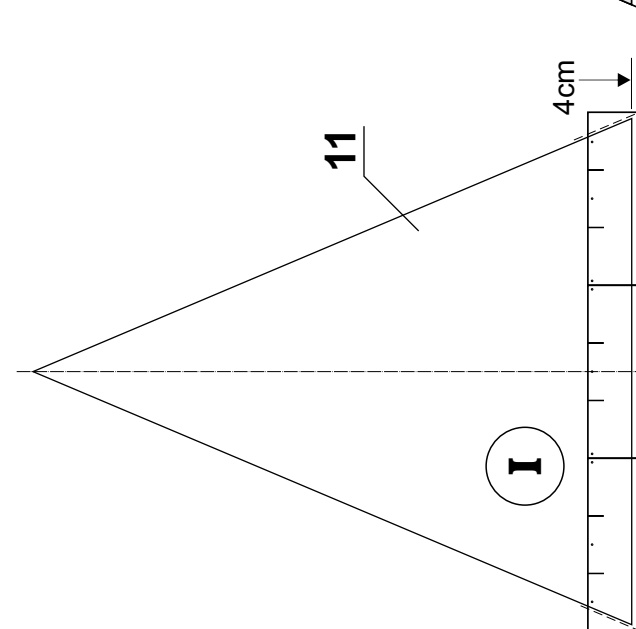
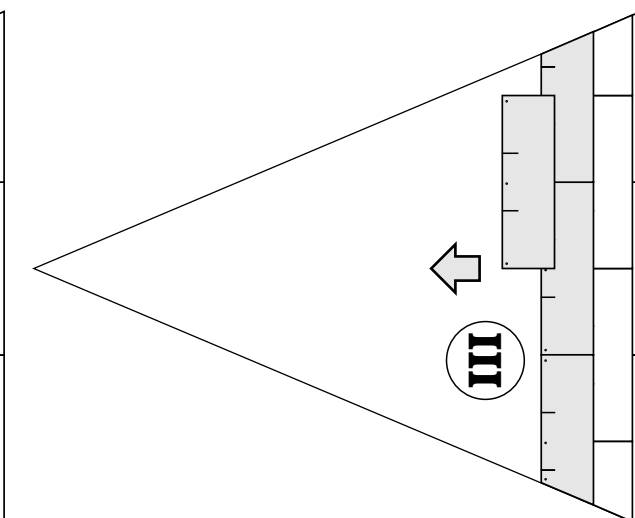
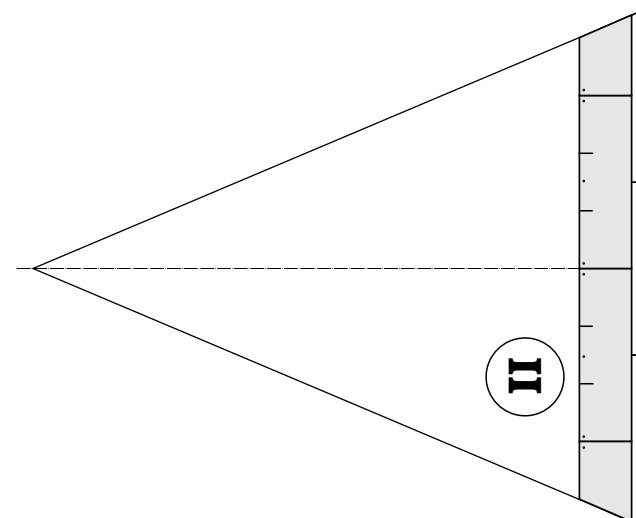
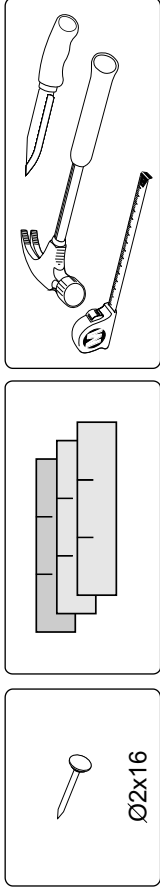

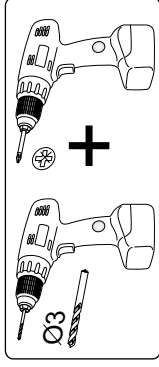
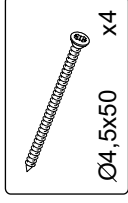
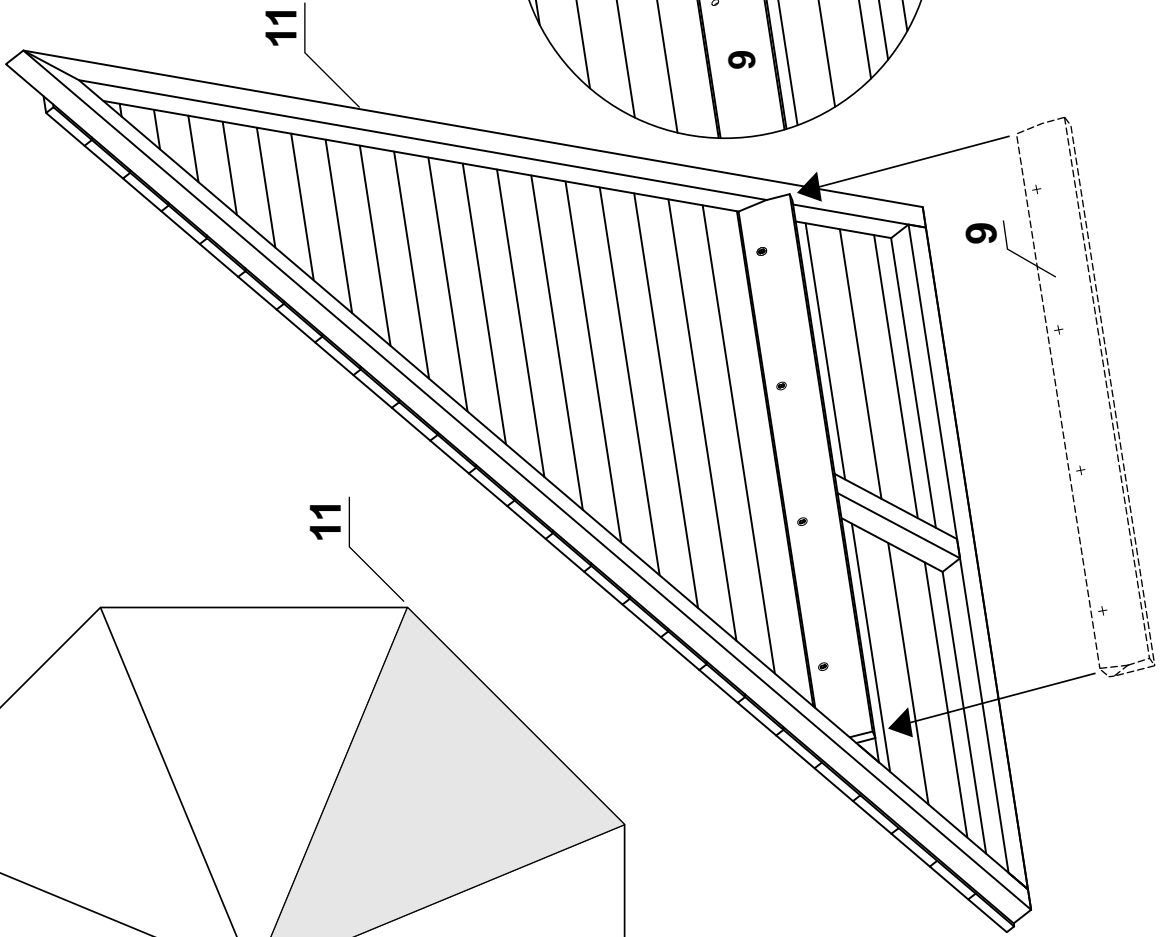
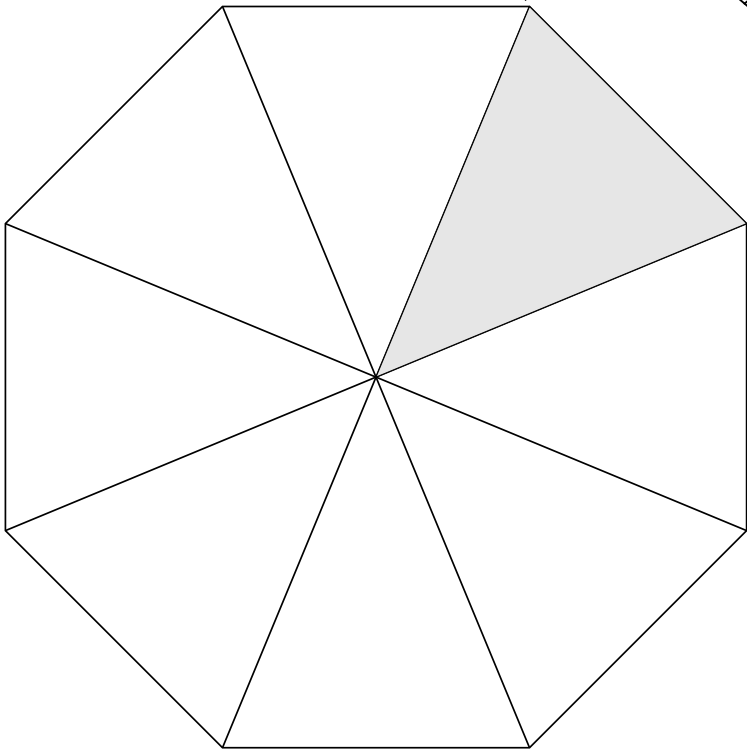

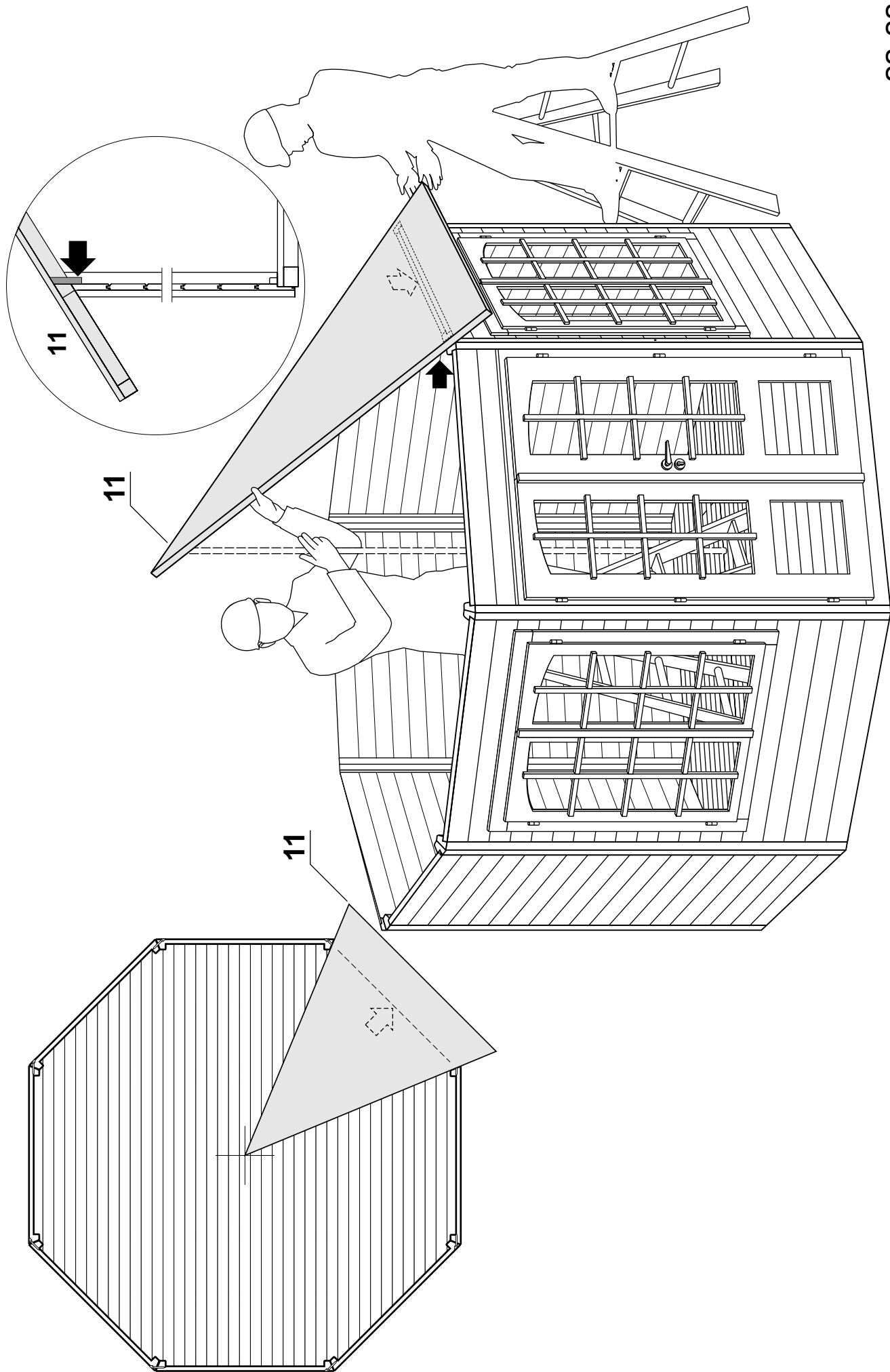

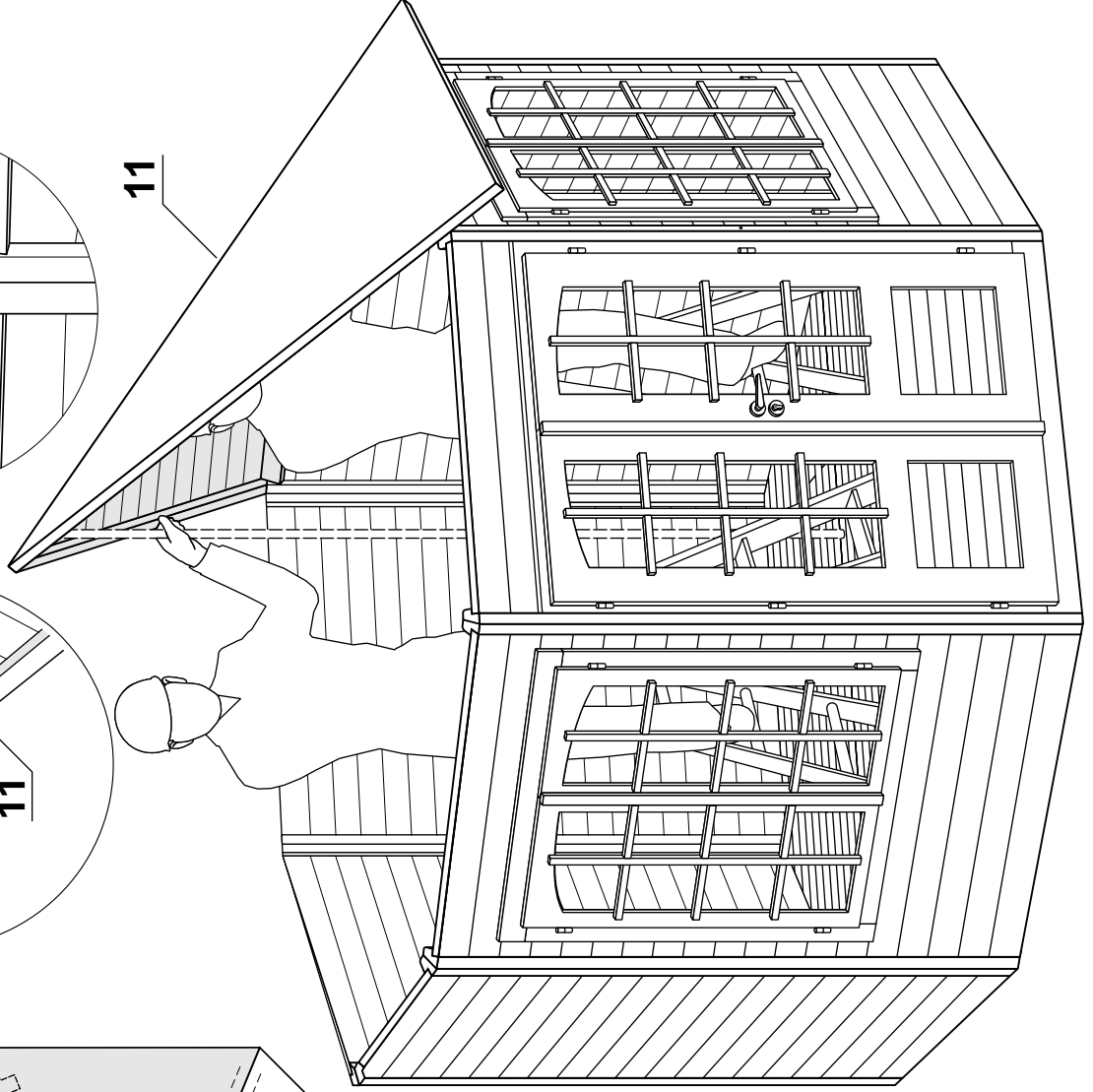
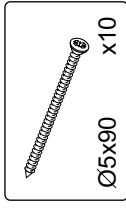
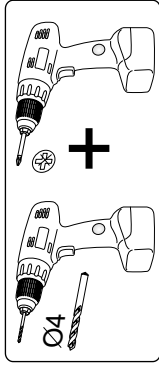
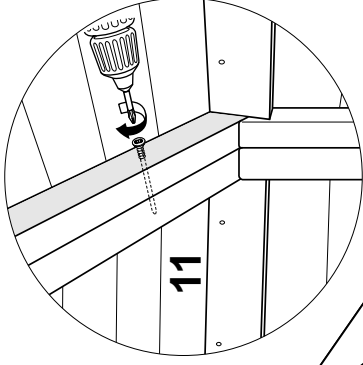
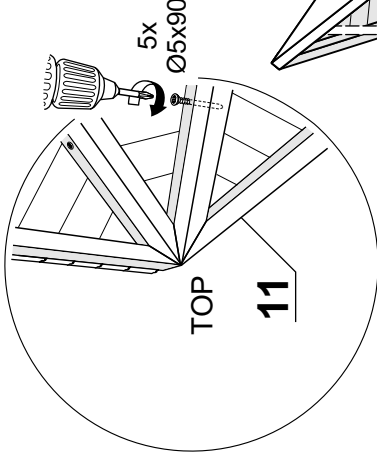
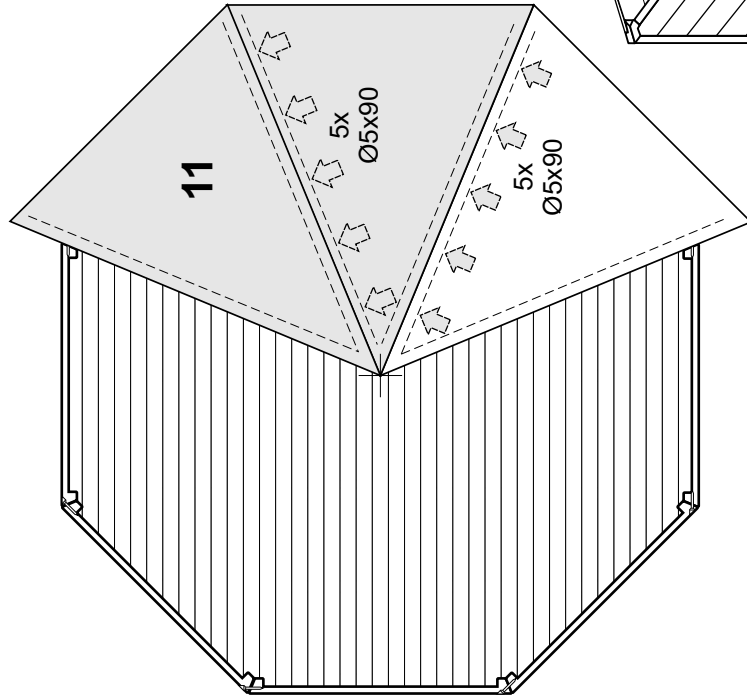

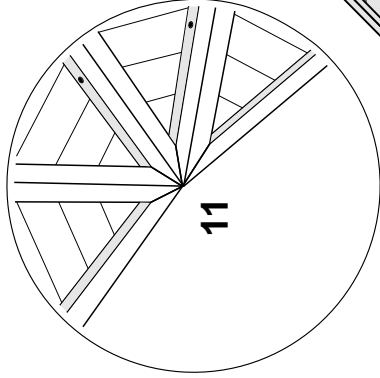
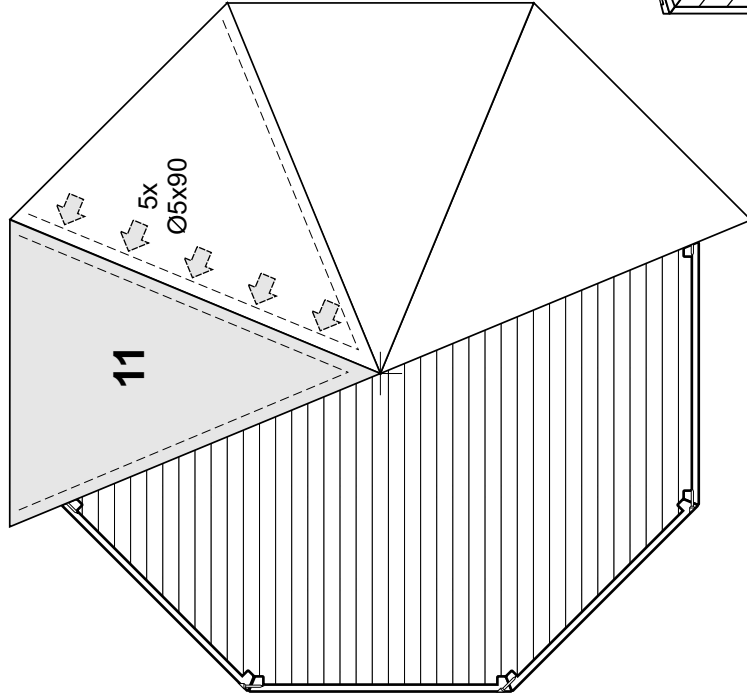

5x  
Ø5x90

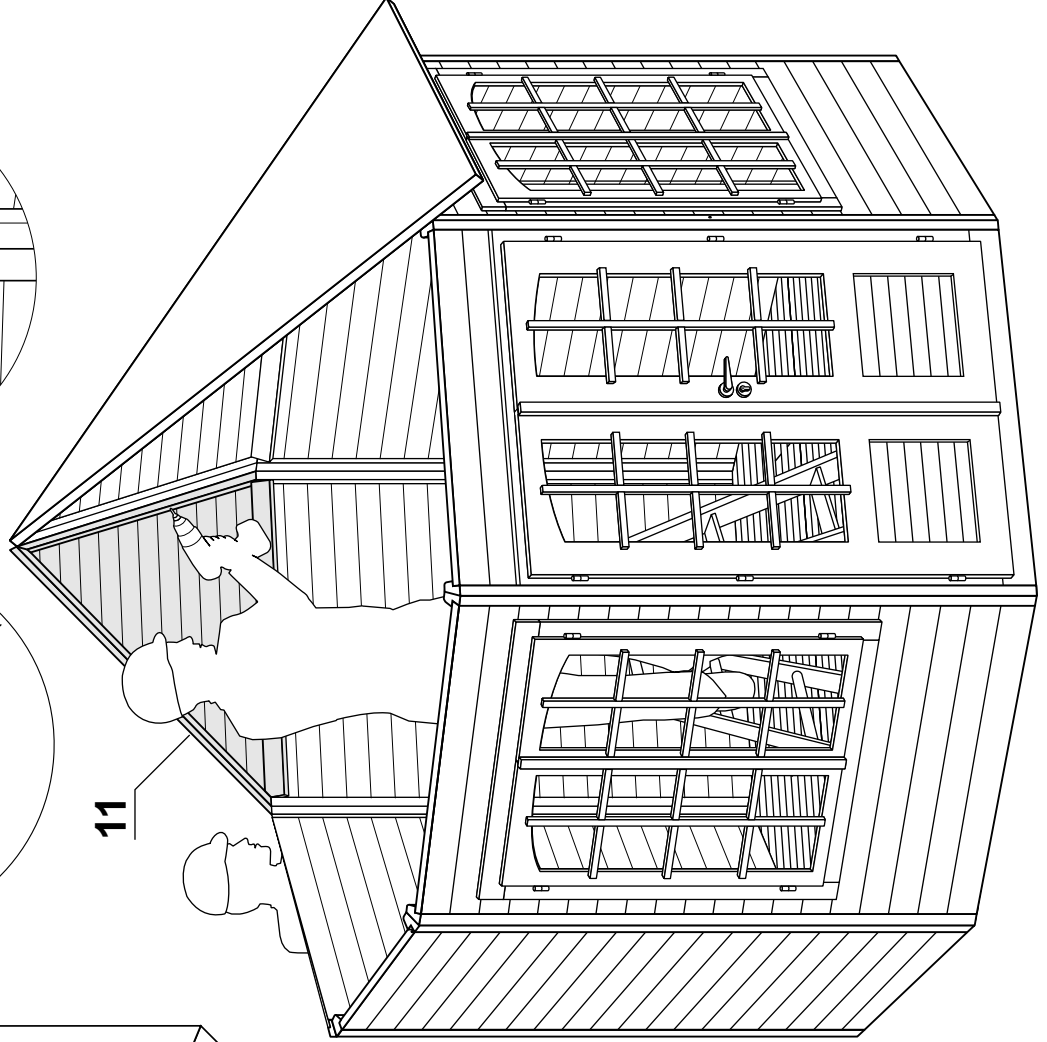
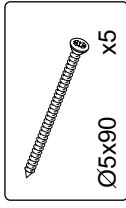
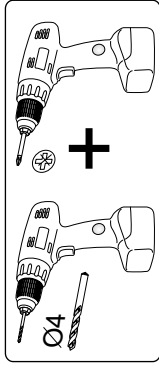
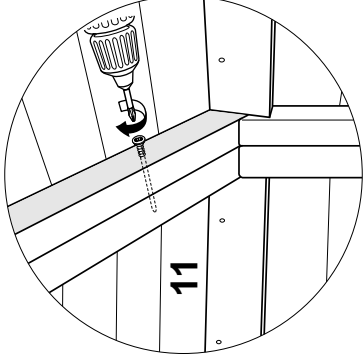



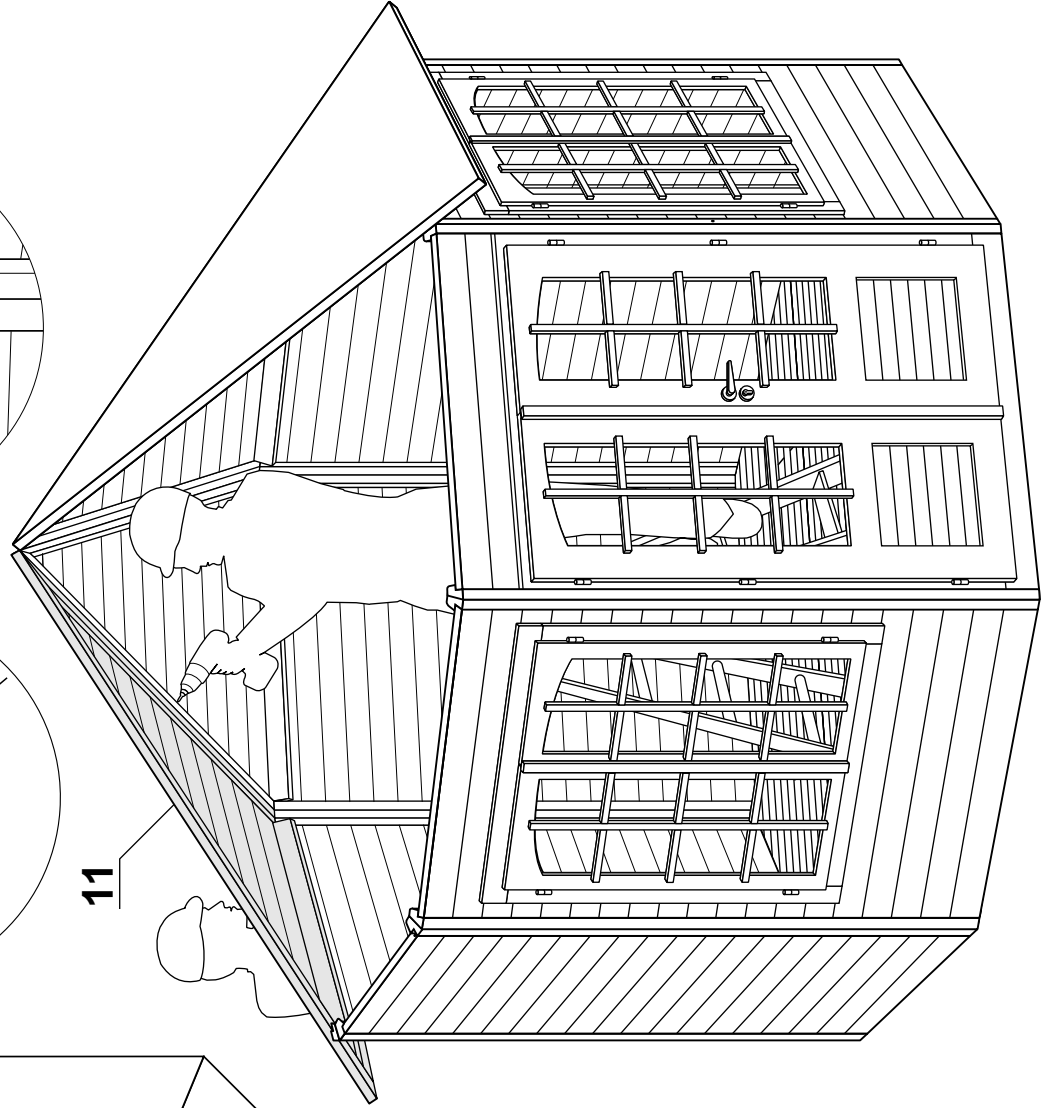
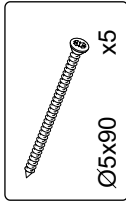
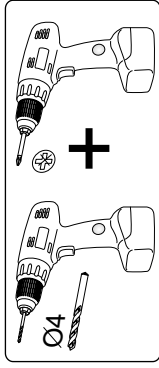
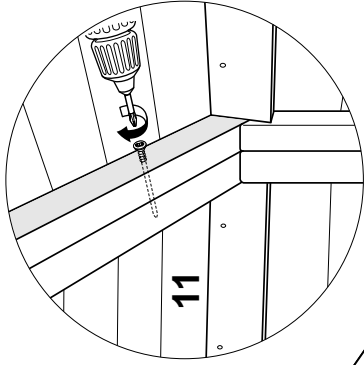
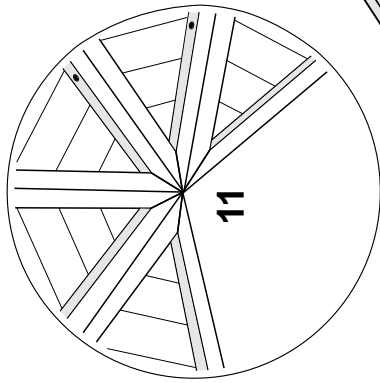
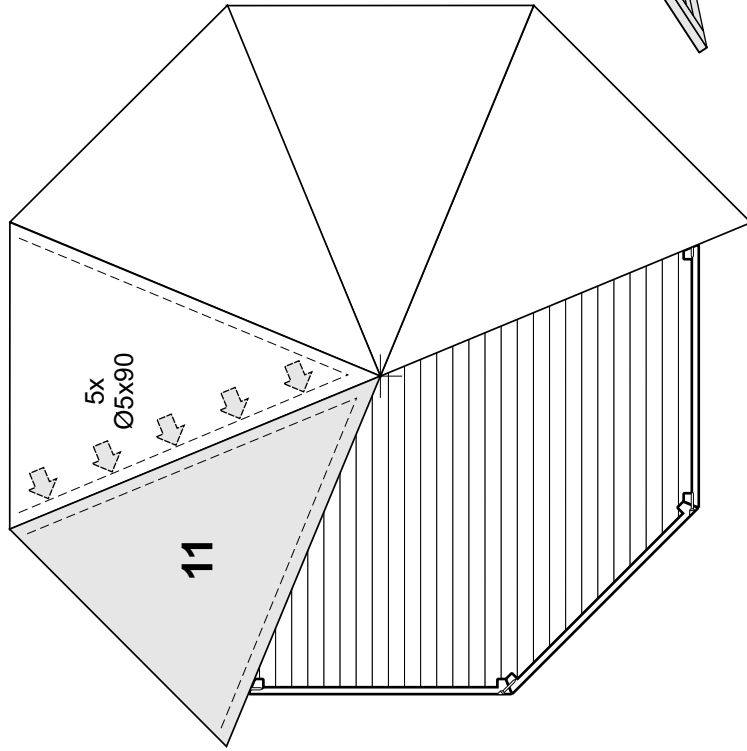

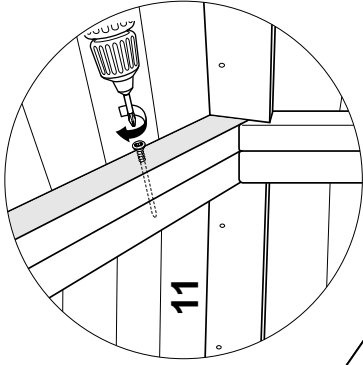
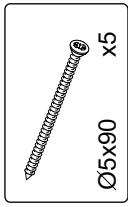
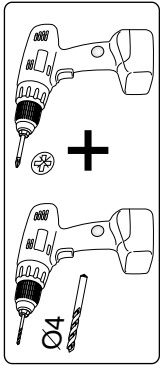

5x  
Ø5x90

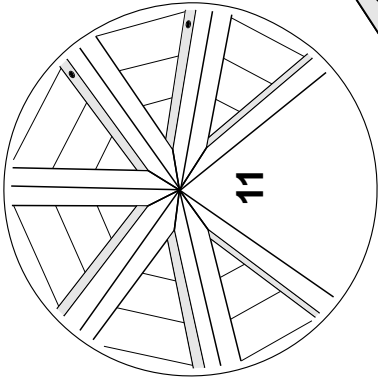

11

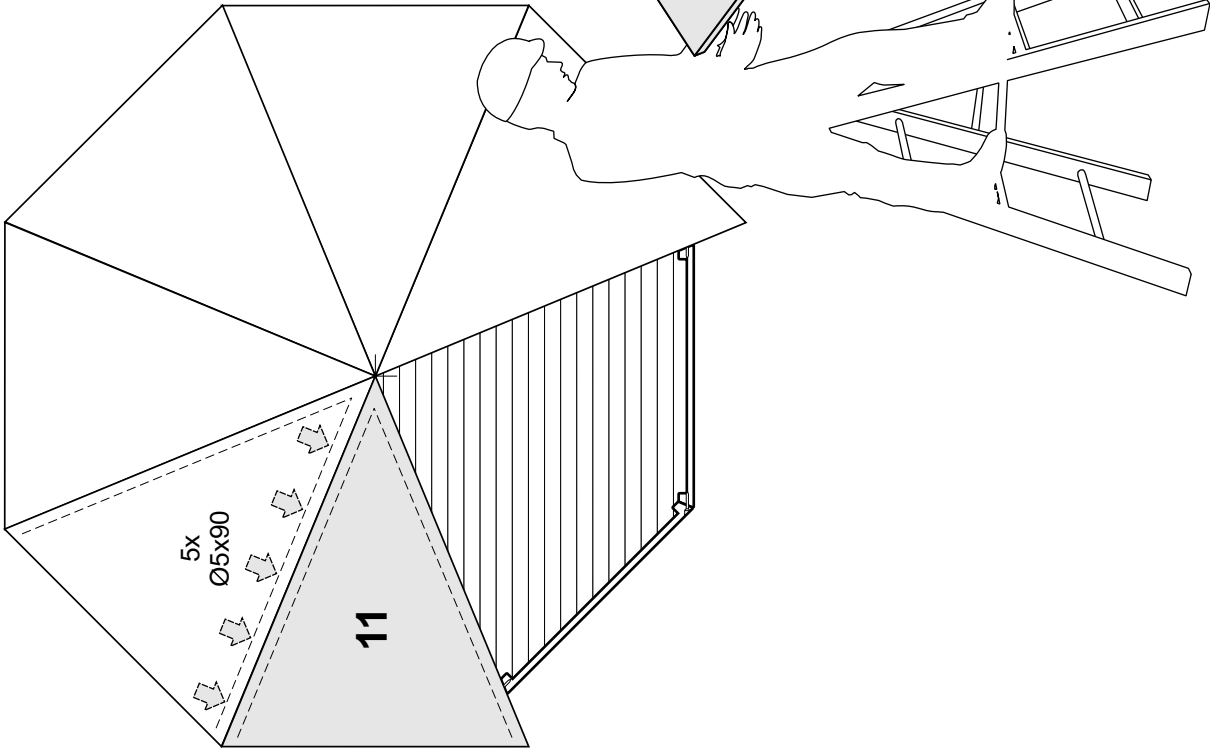

5x  
Ø5x90

11

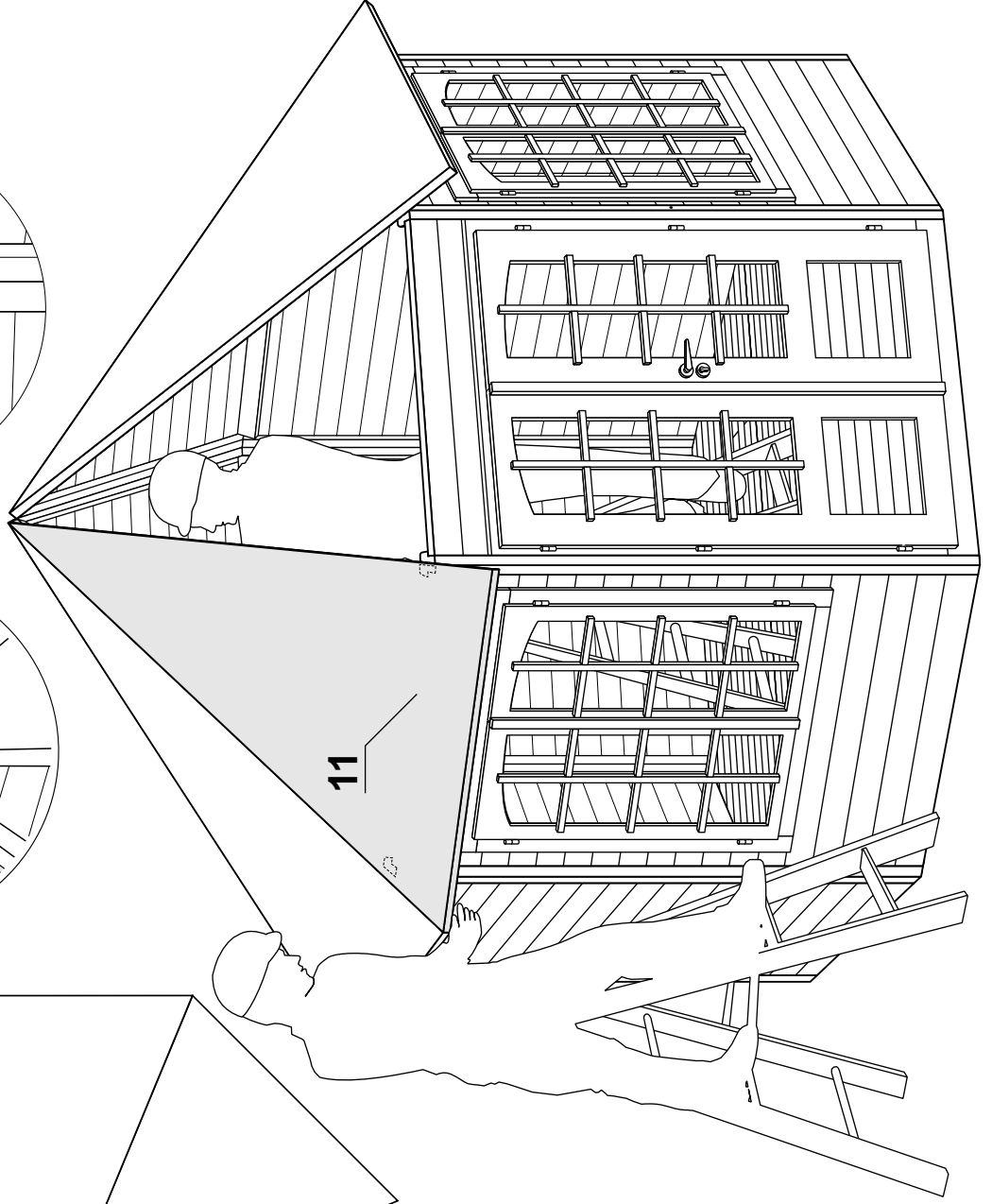
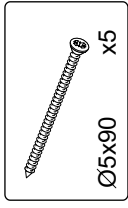
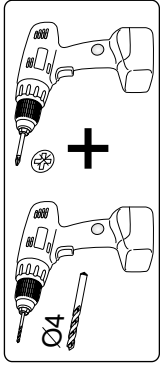
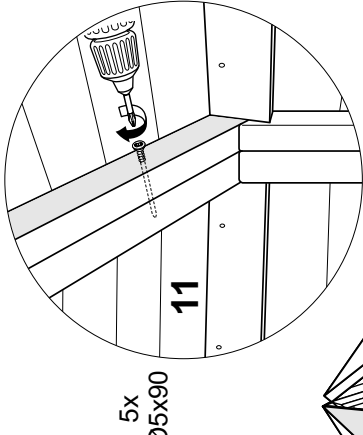
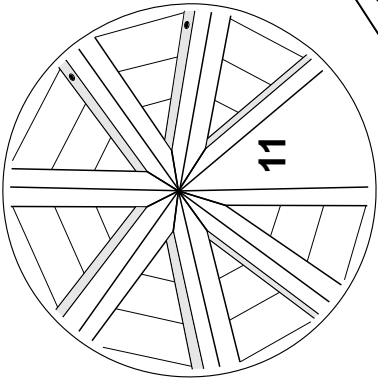
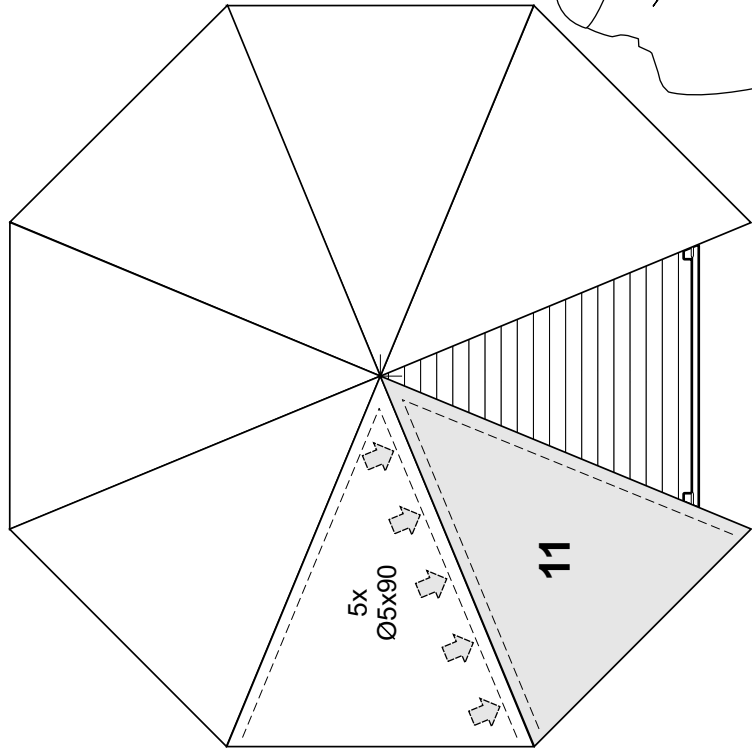

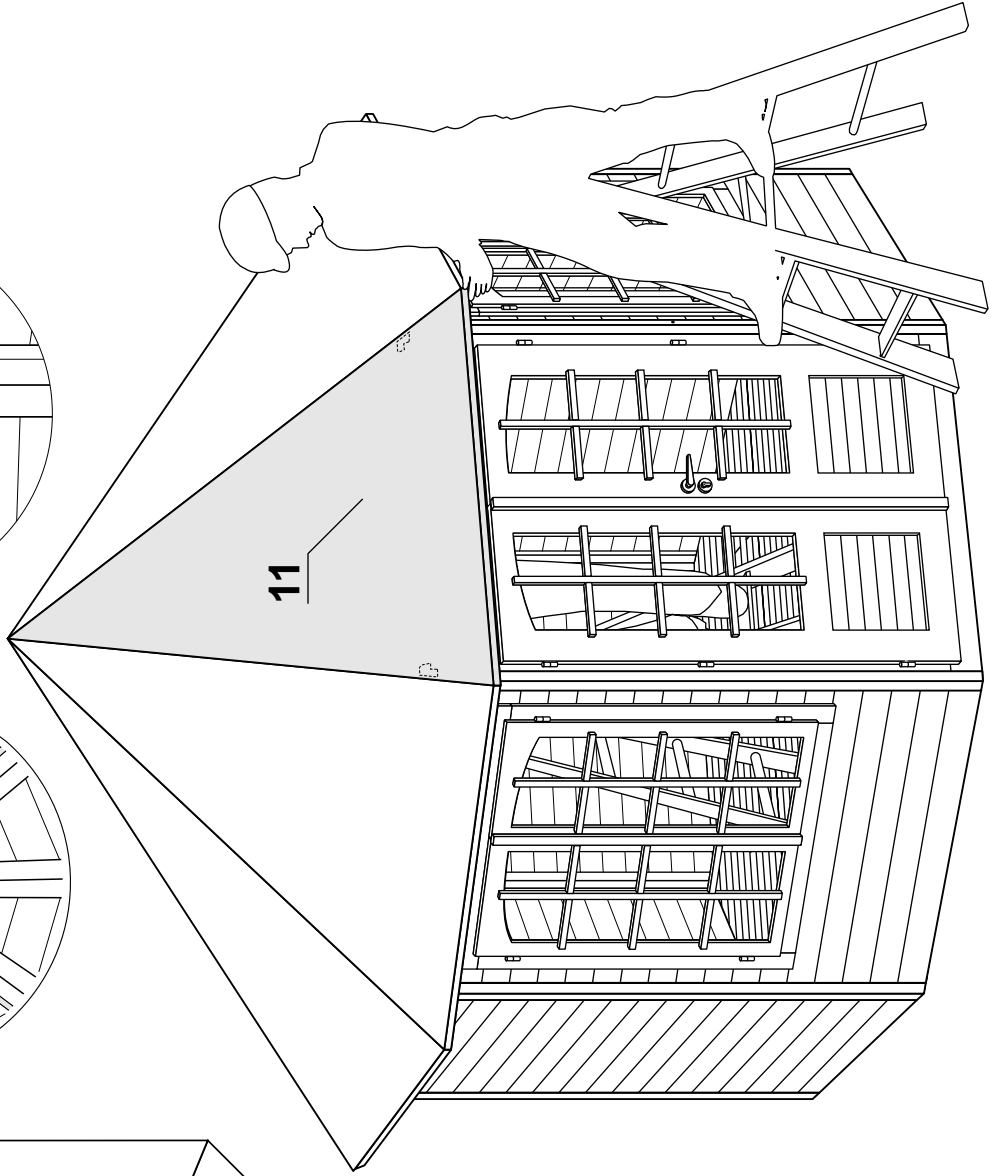
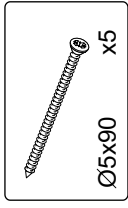
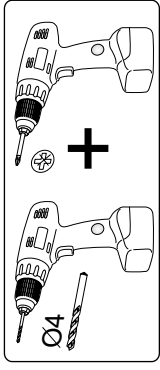
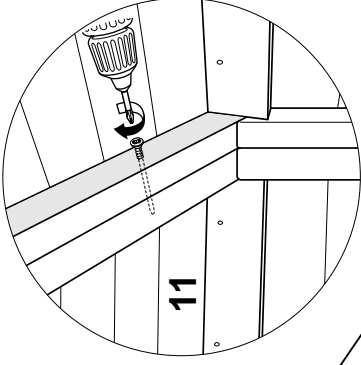
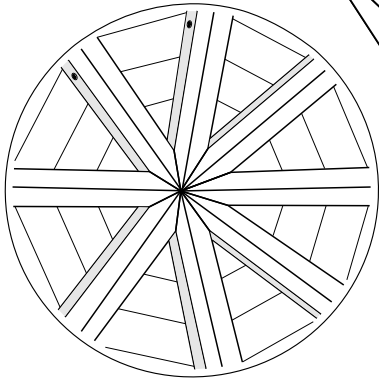
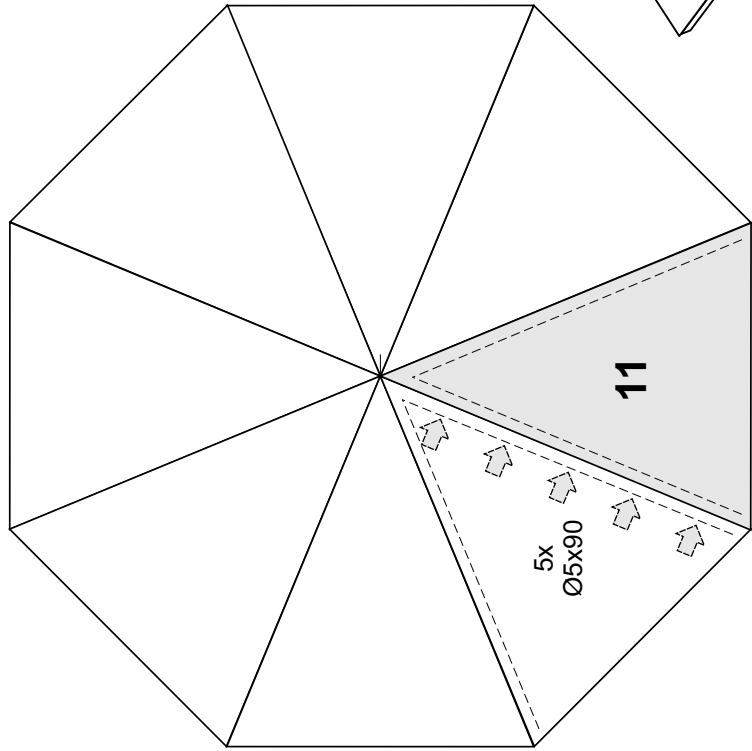

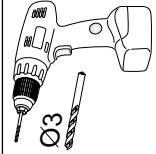
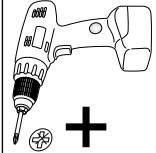
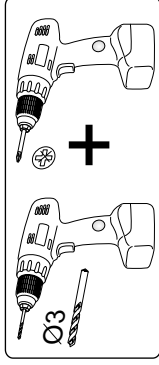
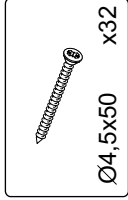
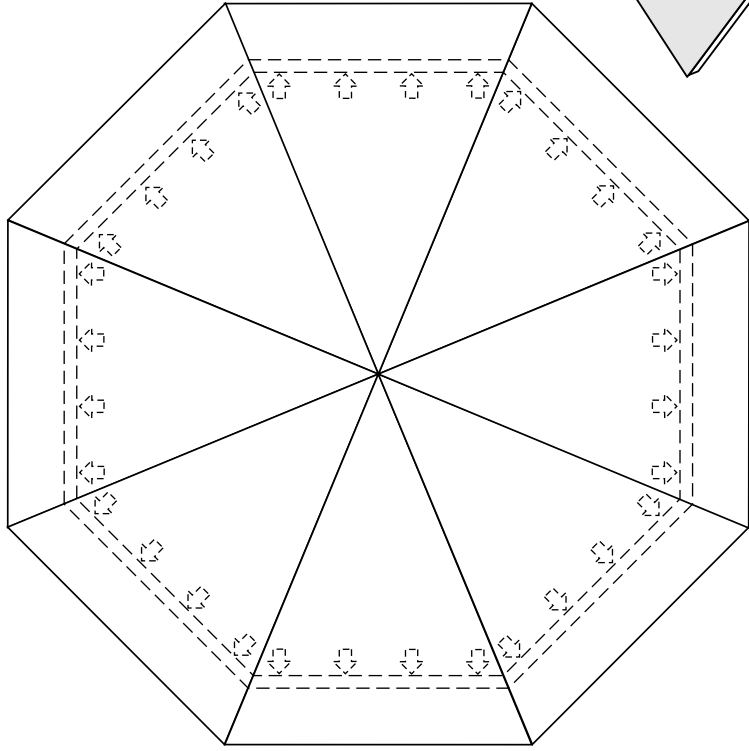

+

+

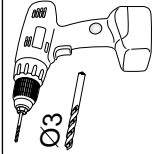
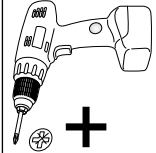

Ø3

+

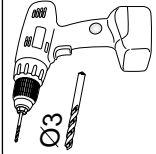
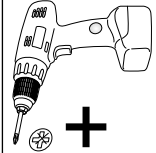

Ø3

+

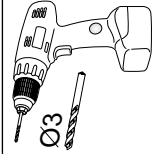
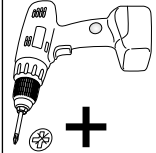

Ø3

+

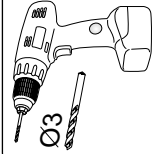
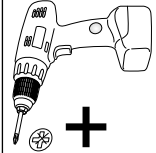

Ø3

+

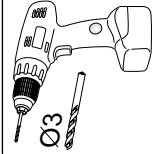
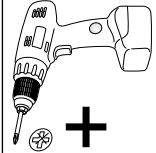

Ø3

+

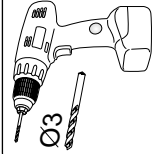
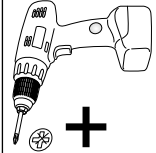

Ø3

+

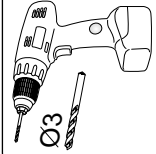
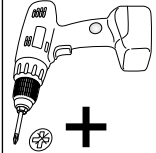

Ø3

+

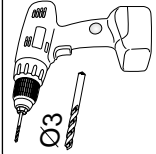
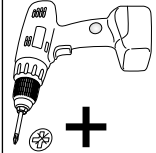

Ø3

+

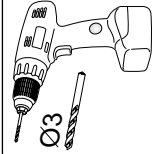
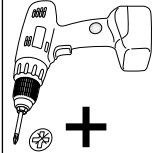

Ø3

+

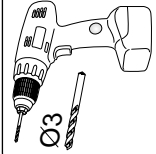
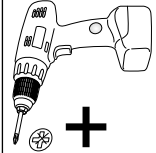

Ø3

+

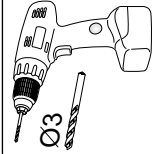
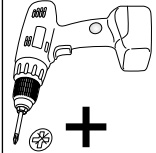

Ø3

+

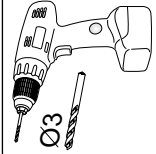
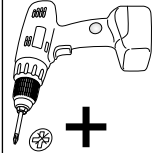

Ø3

+

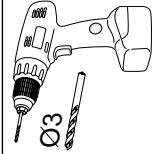
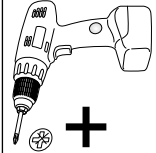

Ø3

+

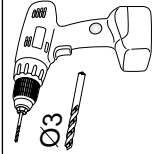
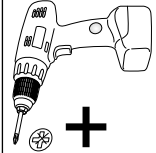

Ø3

+

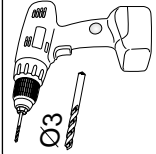
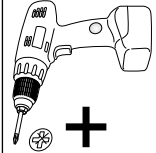

Ø3

+

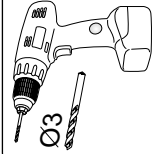
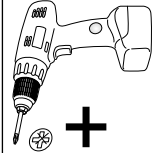

Ø3

+

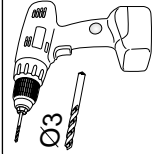
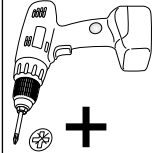

Ø3

+

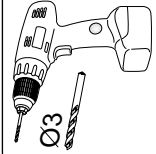
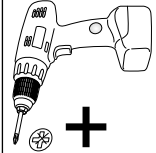

Ø3

+

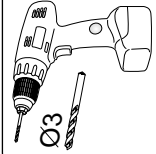
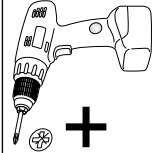

Ø3

+

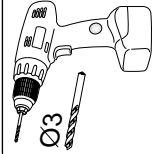
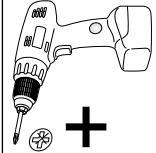

Ø3

+

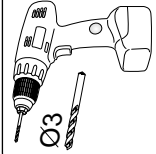
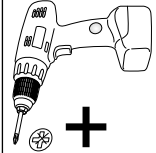

Ø3

+

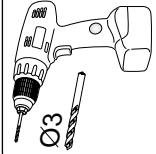
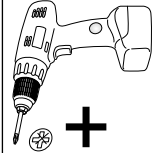

Ø3

+

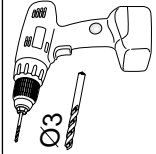
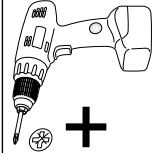

Ø3

+

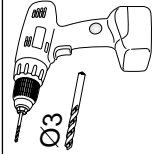
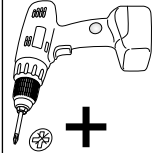

Ø3

+

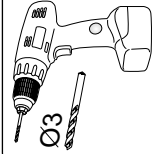
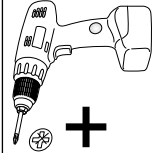

Ø3

+

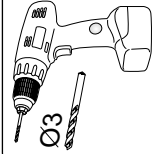
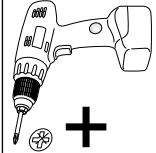

Ø3

+

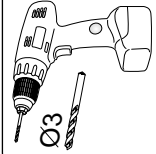
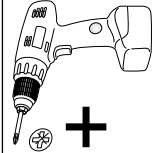

Ø3

+

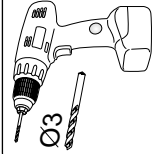
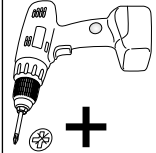

Ø3

+

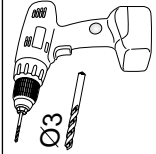
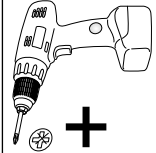

Ø3

+

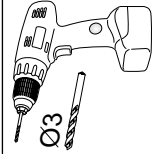
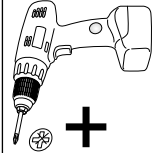

Ø3

+

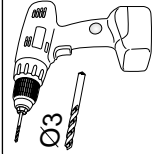
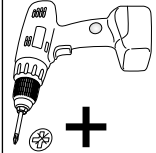

Ø3

+

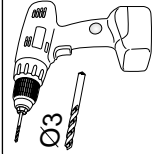
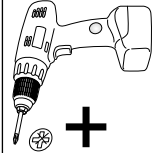

Ø3

+

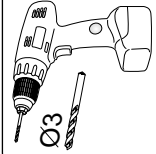
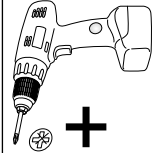

Ø3

+

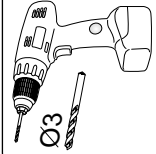
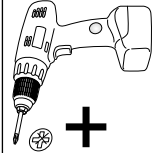

Ø3

+

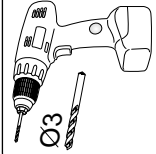
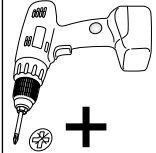

Ø3

+

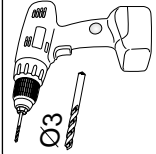
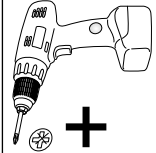

Ø3

+

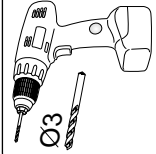
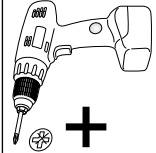

Ø3

+

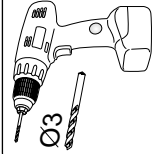
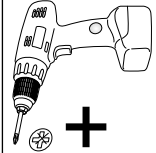

Ø3

+

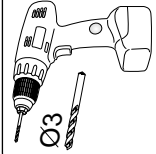
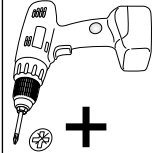

Ø3

+

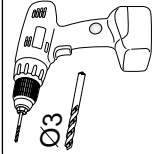
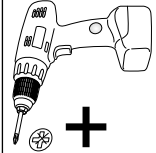

Ø3

+

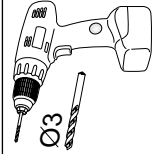
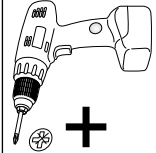

Ø3

+

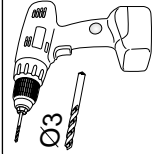
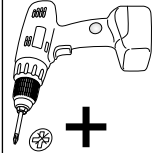

Ø3

+

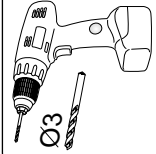
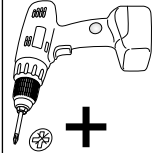

Ø3

+

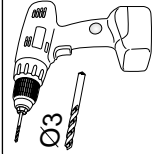
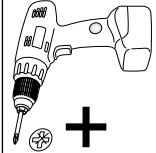

Ø3

+

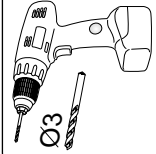
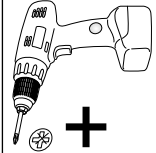

Ø3

+

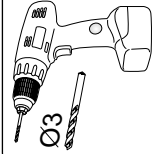
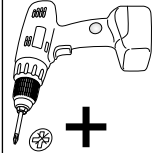

Ø3

+

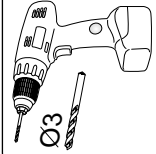
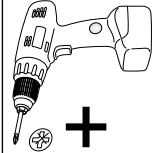

Ø3

+

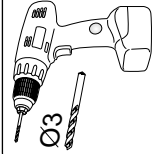
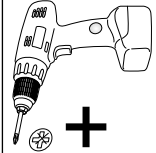

Ø3

+

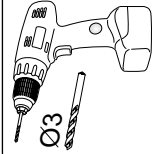
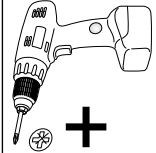

Ø3

+

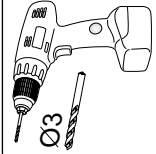
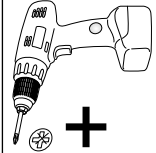

Ø3

+

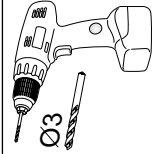
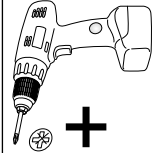

Ø3

+

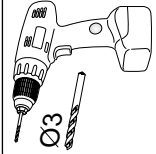
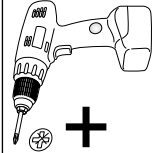

Ø3

+

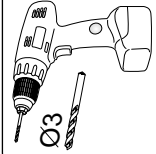
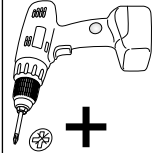

Ø3

+

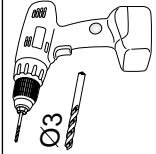
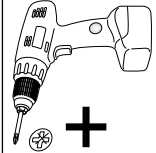

Ø3

+

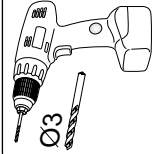
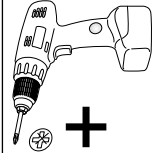

Ø3

+

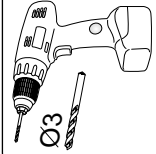
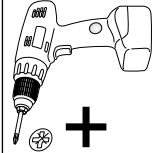

Ø3

+

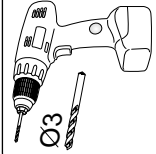
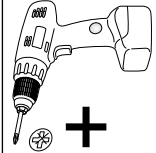

Ø3

+

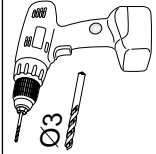
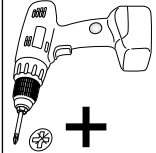

Ø3

+

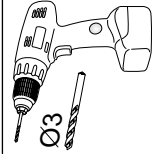
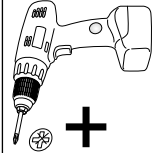

Ø3

+

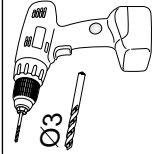
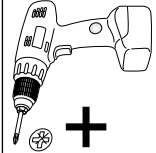

Ø3

+

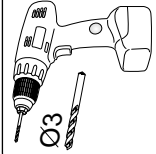
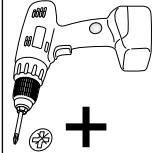

Ø3

+

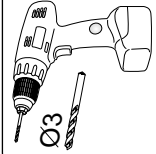
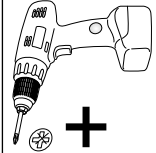

Ø3

+

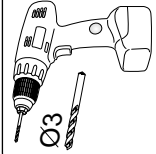
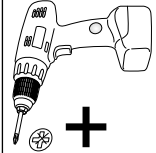

Ø3

+

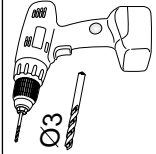
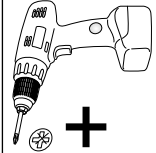

Ø3

+

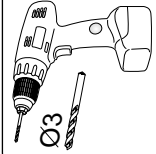
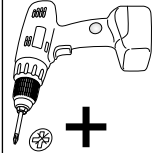

Ø3

+

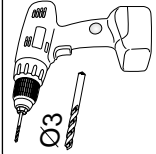
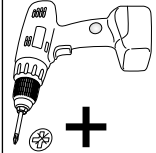

Ø3

+

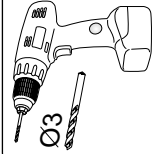
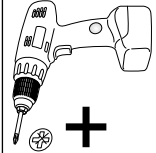

Ø3

+

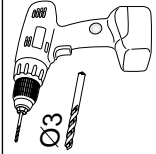
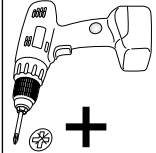

Ø3

+

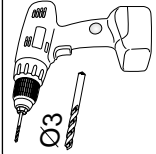
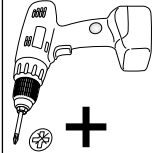

Ø3

+

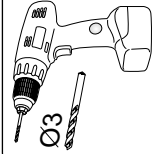
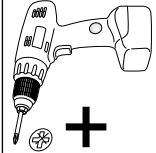

Ø3

+

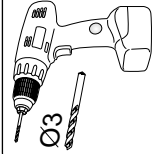
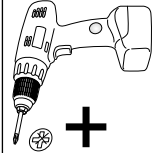

Ø3

+

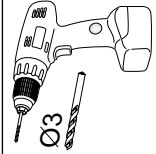
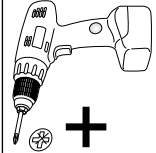

Ø3

+

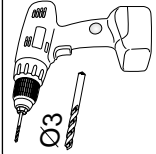
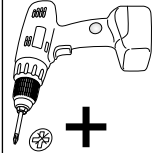

Ø3

+

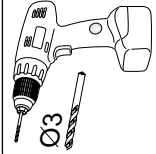
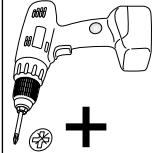

Ø3

+

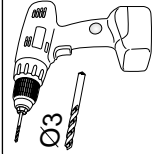
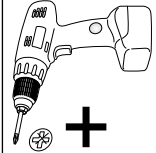

Ø3

+

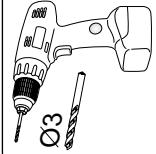
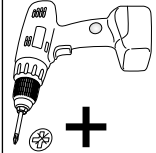

Ø3

+

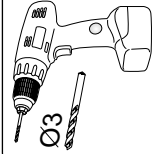
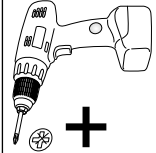

Ø3

+

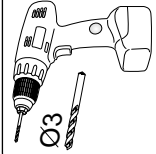
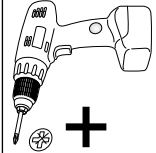

Ø3

+

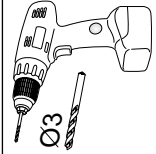
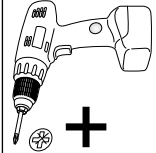

Ø3

+

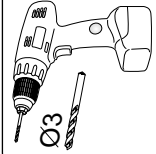
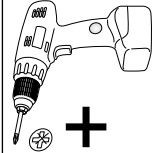

Ø3

+

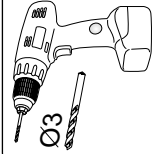
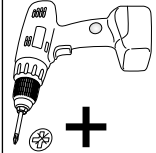

Ø3

+

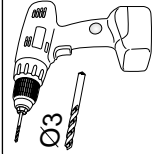
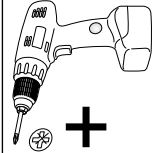

Ø3

+

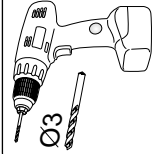
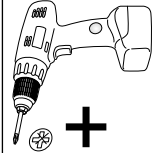

Ø3

+

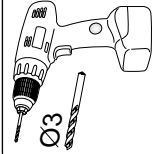
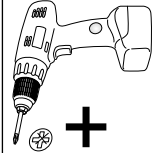

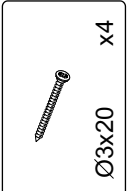
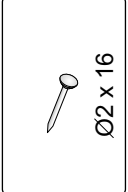
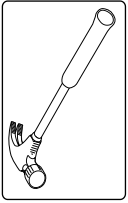
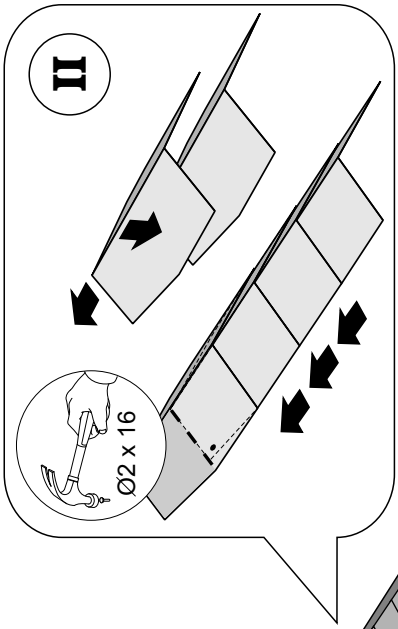
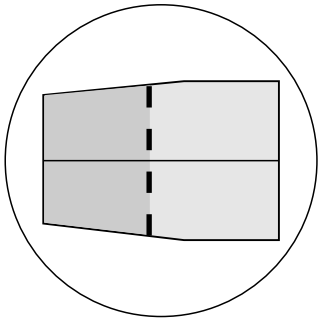
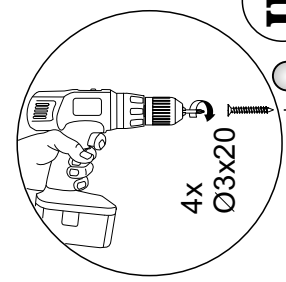
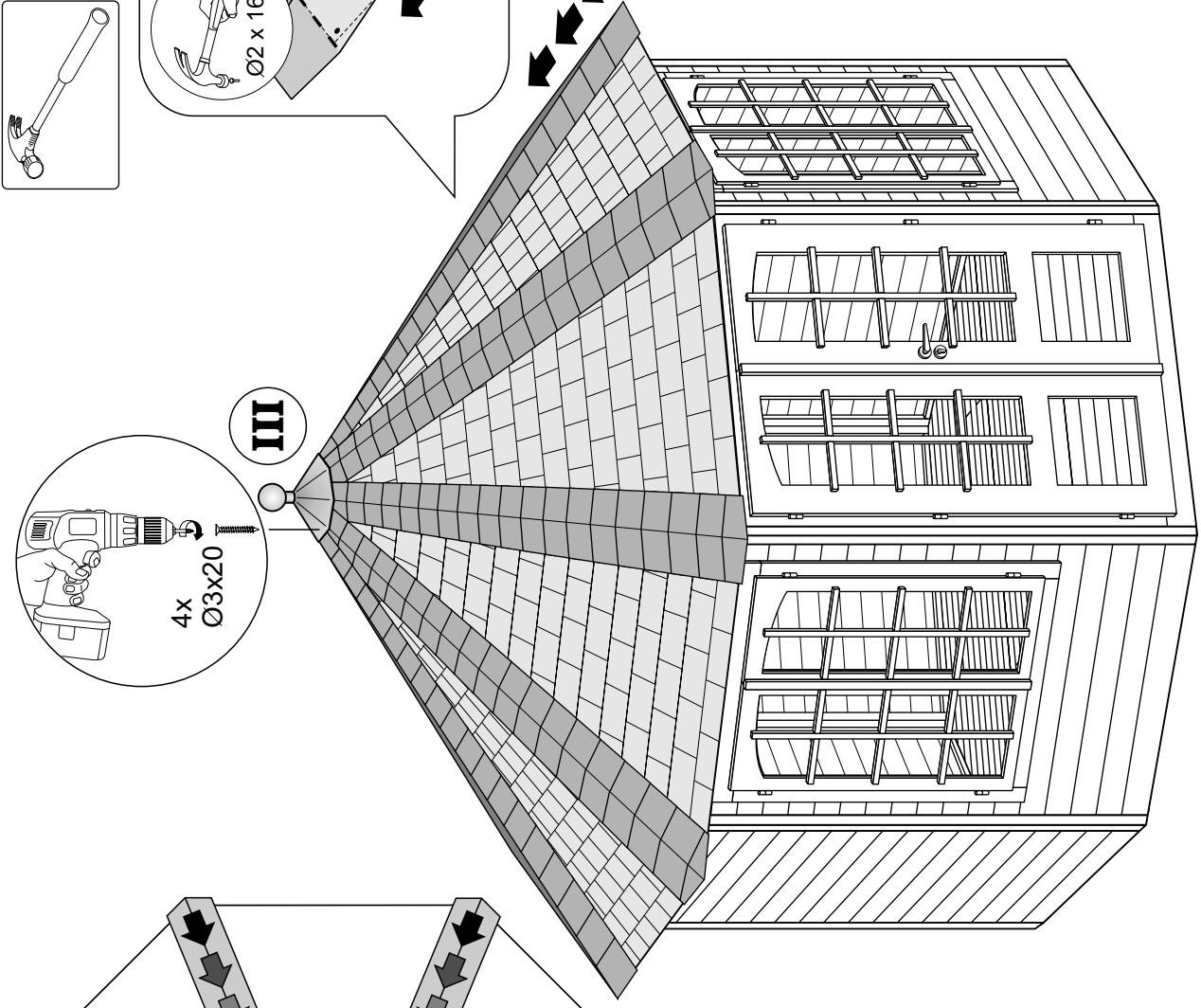
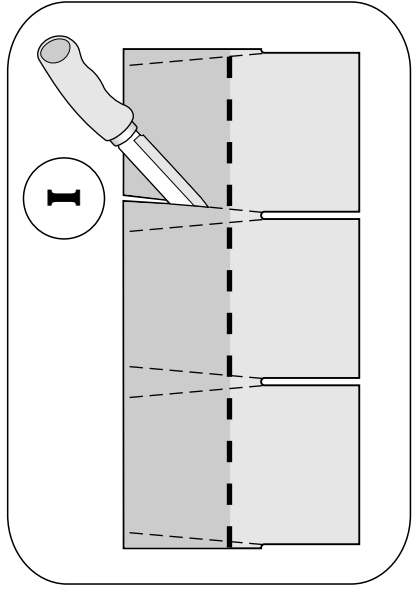
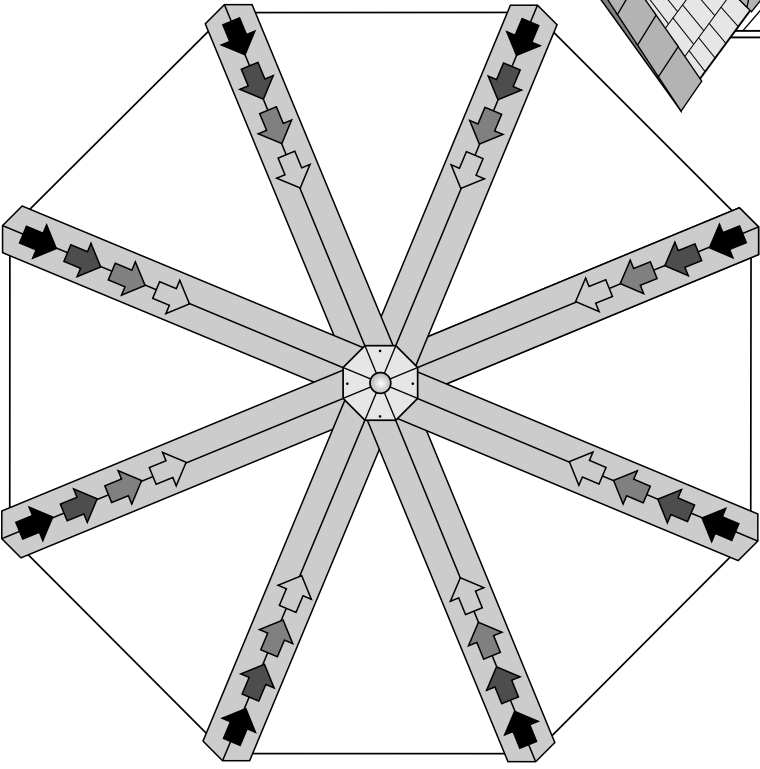

Ø3x20 x4

Ø2 x 16

II

III

4x  
Ø3x20

I

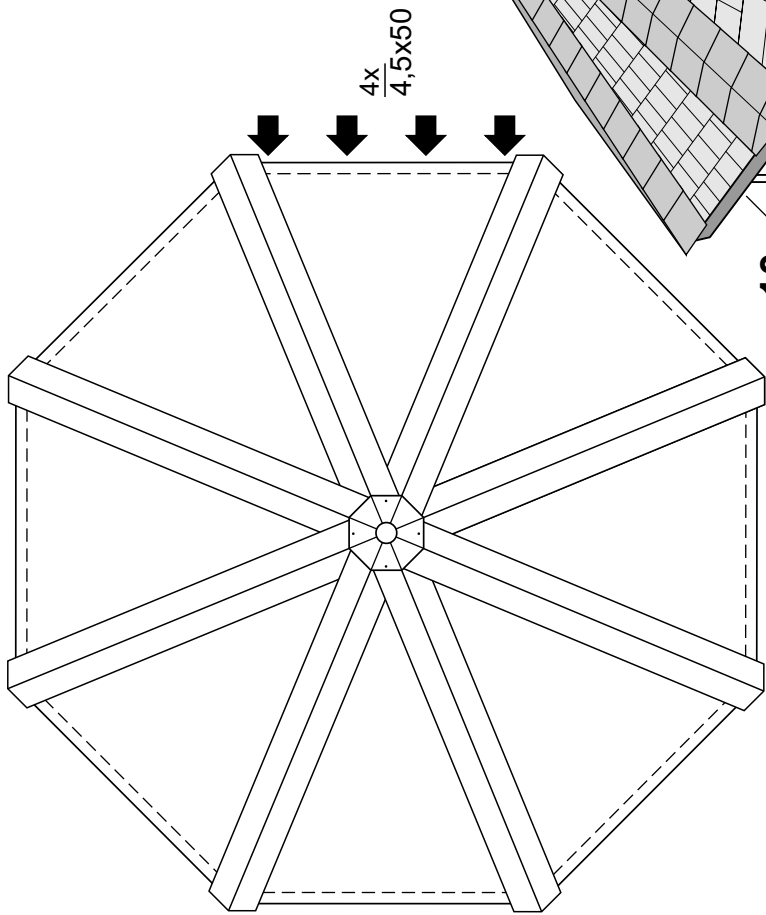

Ø4,5x50 x32

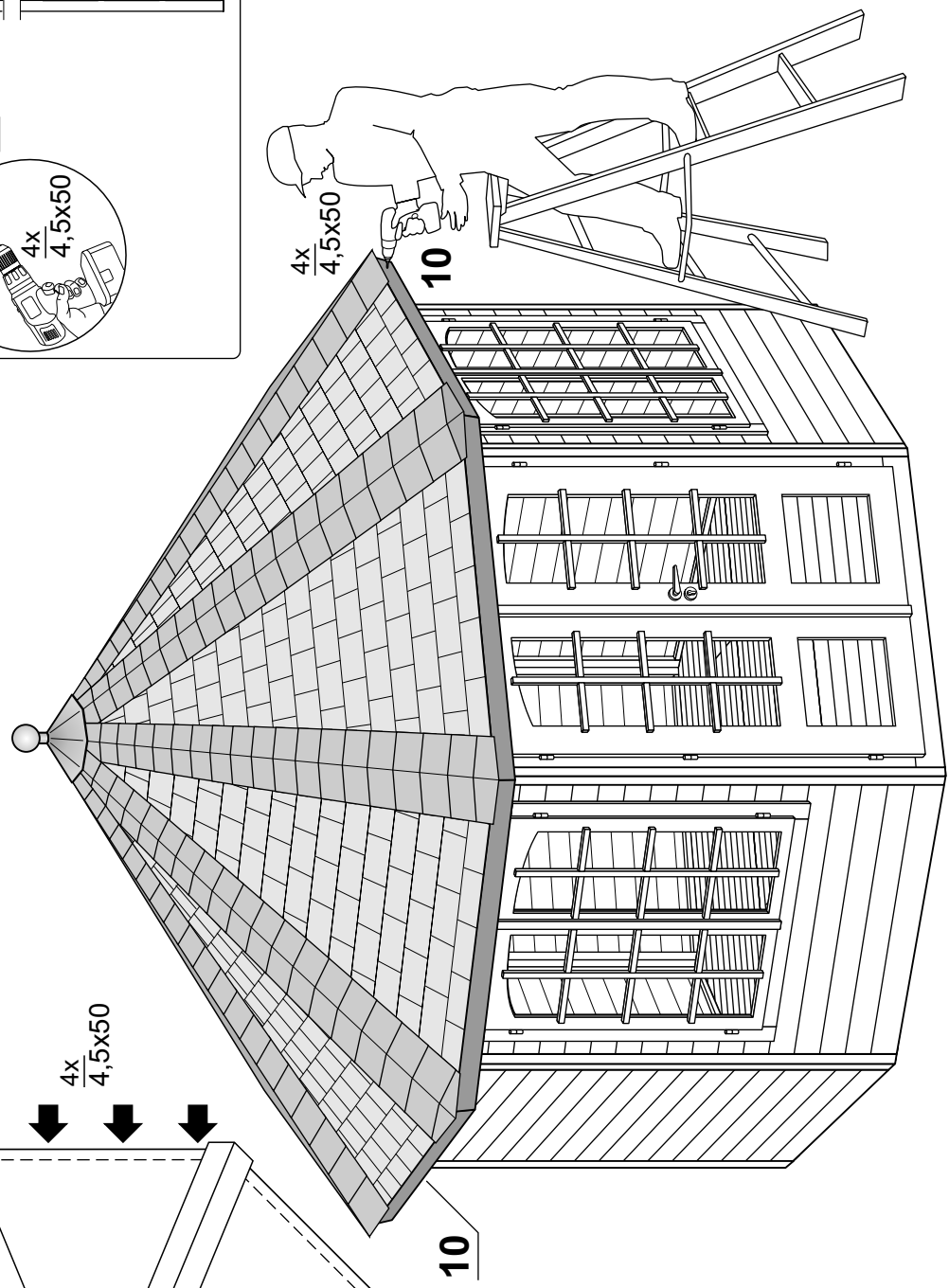
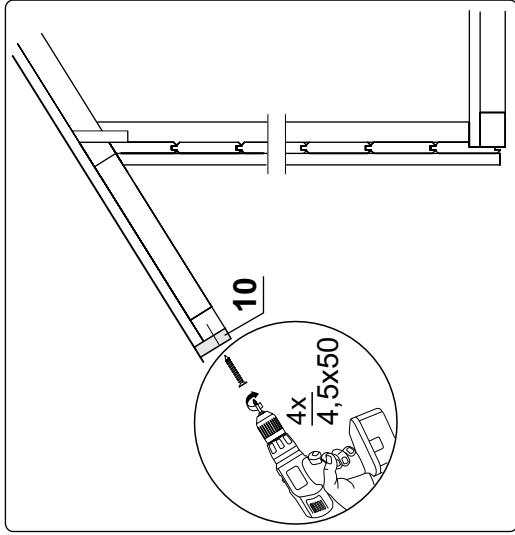
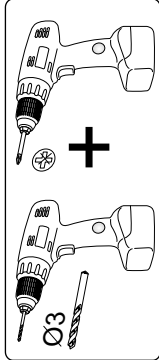

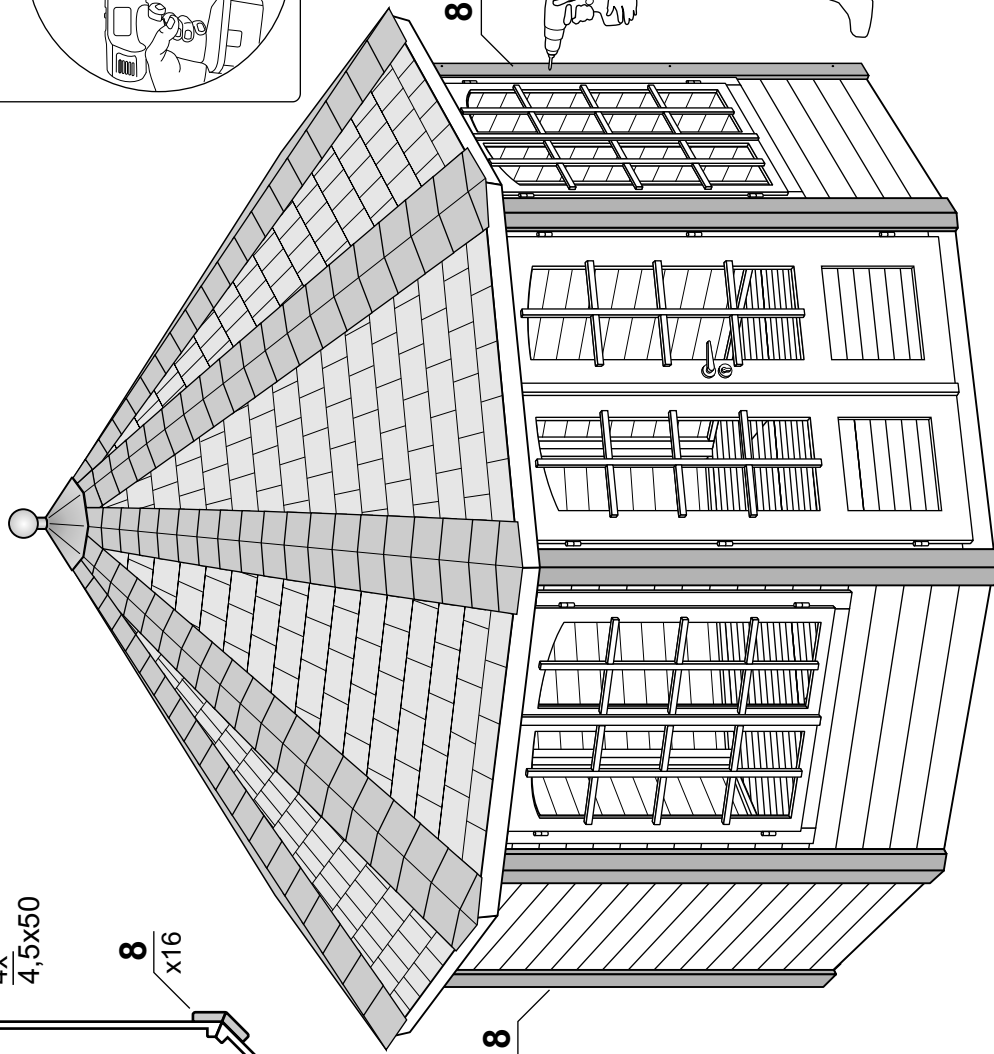
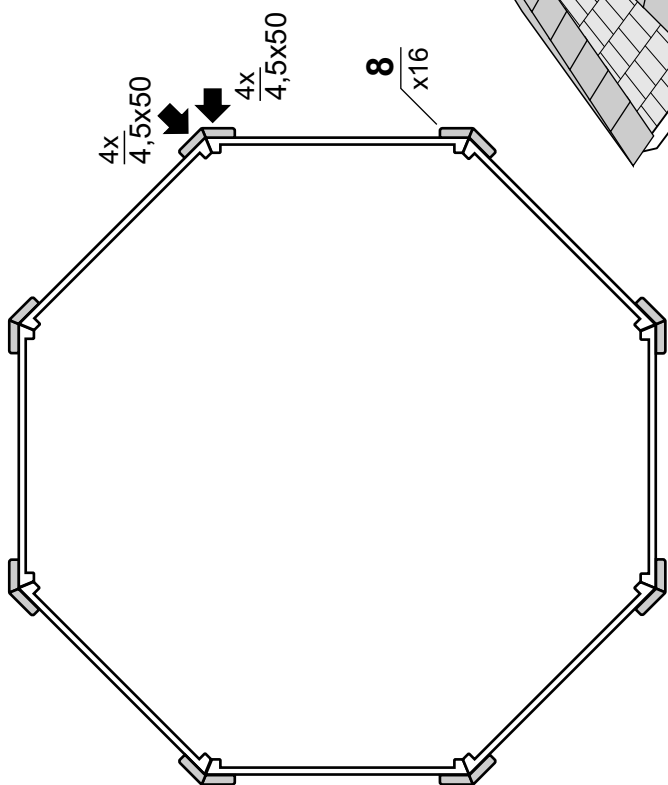
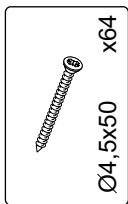
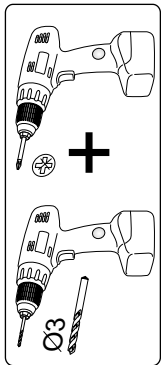
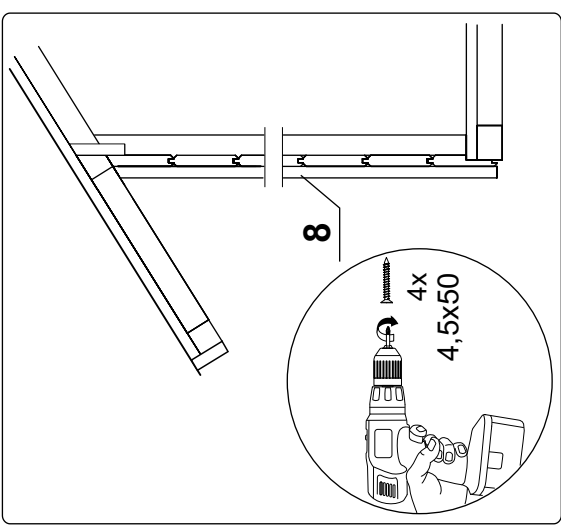



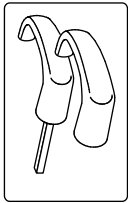
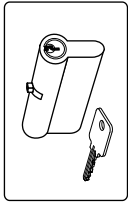
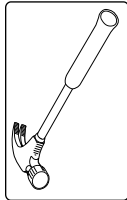
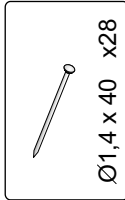
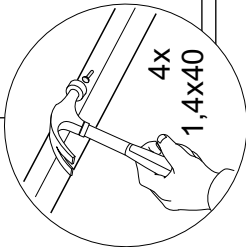
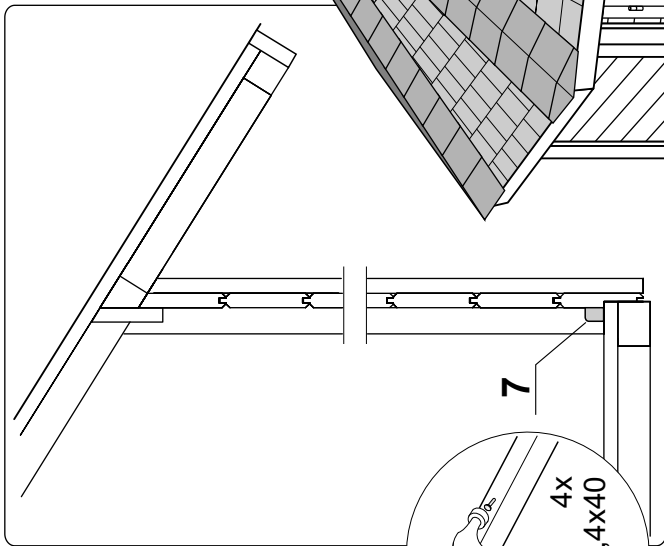
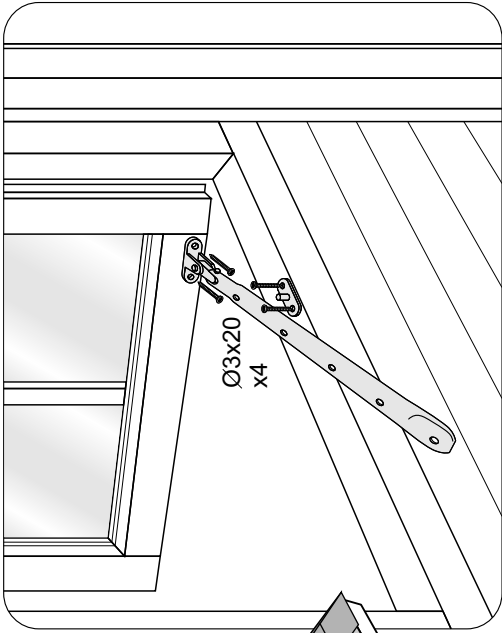
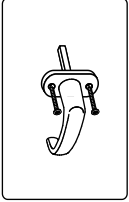
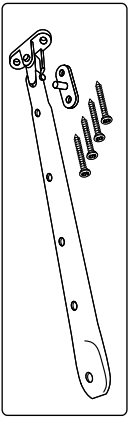

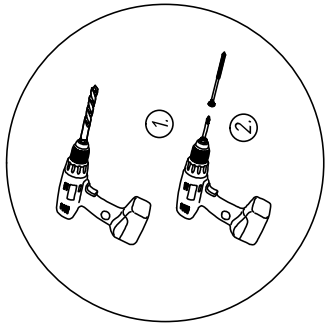
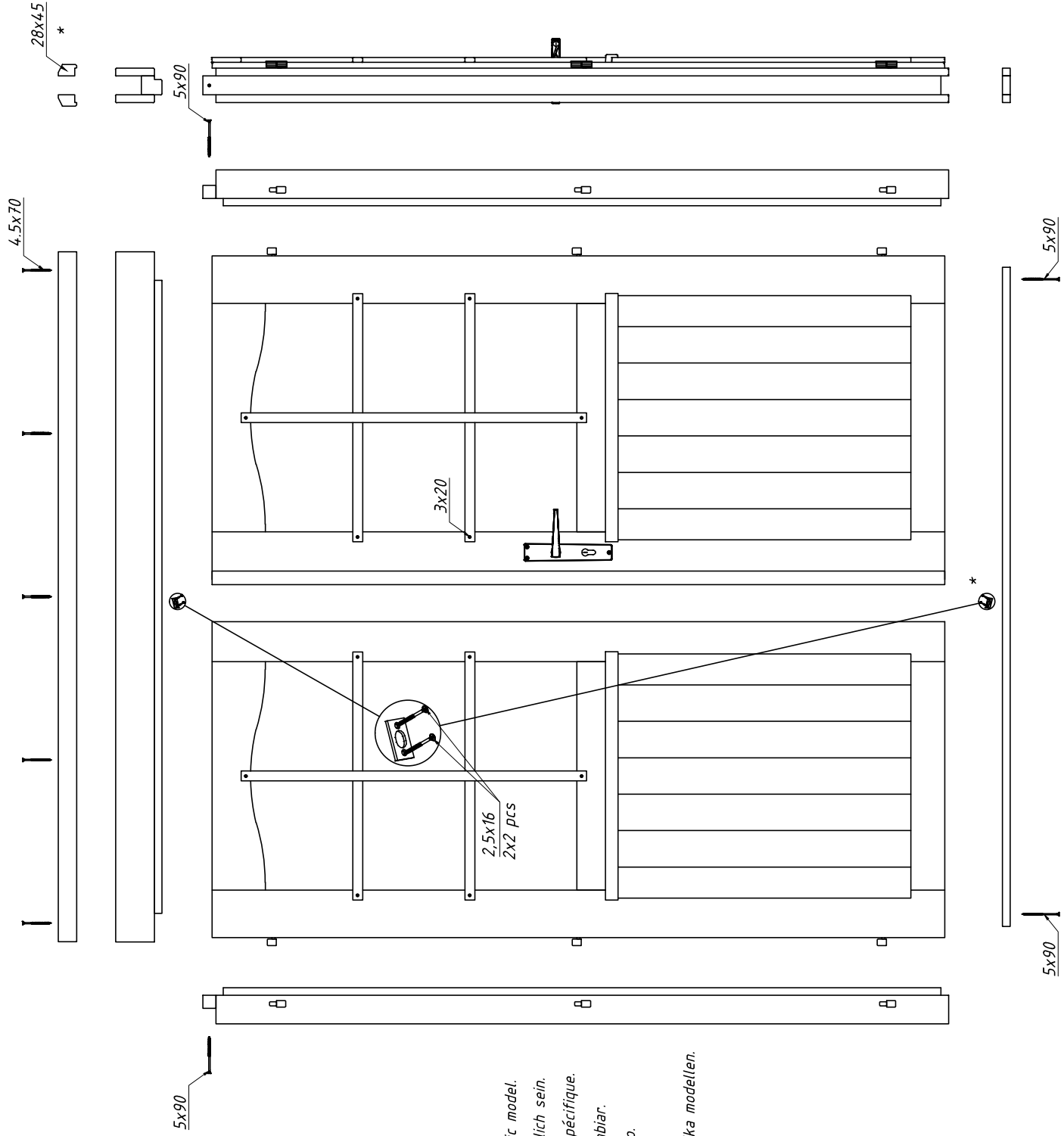

- \* The specification may vary depending on the specific model.
- \* Die Spezifikation können je nach Modell unterschiedlich sein.
- \* Les spécifications peuvent varier selon le modèle spécifique.
- \* Dependiendo del modelo, la especificación puede cambiar.
- \* Le specifiche possono variare a seconda del modello.
- \* Tekniset tiedot voivat vaihdella mallista riippuen.
- \* Specifikationen kan variera beroende på den specifika modellen.

